



Compact length measuring instrument



Millimar C 1202

Operating Instructions

Valid from firmware version 1.0.0.1

3723010

Mahr GmbH

Carl-Mahr-Straße 1
D-37073 Göttingen
Tel. +49 551 7073 0

info@mahr.com, www.mahr.com

Dear customer,

Thank you for choosing a product by Mahr GmbH. We kindly request that you follow the instructions below to ensure the long-term precision of your instrument.

We operate a policy of continuous improvement and are constantly developing our products. Therefore, it is possible that there may be slight differences between the text and illustrations in this document and the instrument in your possession, especially with regard to type designations. We reserve the right to make changes to the design and scope of supply, the right to undertake further technical developments, and all rights relating to translation of this documentation.

© by Mahr GmbH

The following symbols are used in these operating instructions:



General information



Caution



Caution, hazard

Failure to follow instructions marked with this symbol can cause inaccurate results and lead to equipment damage.

Introduction

Permitted uses

The Millimar C 1202 is an electronic length measuring and evaluation instrument for use in production. Depending on the N 1700 module used, e.g. two inductive or incremental measuring probes, one or two pneumatic measuring instruments can be connected.

The operating, maintenance and repair information detailed in this quick guide and these operating instructions must be followed.

To gain maximum benefit from this measuring instrument, you must read the instructions before placing it into operation.

The measuring instrument is most accurate after a warm-up period of at least 30 minutes.

The Millimar C 1202 must only be used with the supplied AC adapter.

The full operating instructions can be downloaded at:
www.mahr.com/products, on the product page.

The scope of delivery of the length measuring instrument includes:

- Millimar C 1202 measuring instrument
- AC adapter with interchangeable adapters
- Bus termination module
- Micro SD memory card
- Quick guide

! Forfeiture of warranty

Service work caused by viruses that were introduced via a network connection or other data carrier, are generally excluded from warranty services.

Storage temperatures below -10°C or above +50°C and relative humidity levels above 85% will invalidate the warranty for the instrument.



Safety information

This instrument complies with the relevant safety regulations. It was dispatched from our production facility in a good condition and perfect working order. However, failure to follow the instructions given below can cause personal injury or death.

1. Before you connect up and use the measuring instrument for the first time, please read the accompanying documentation.
Follow the safety precautions detailed in the quick guide and operating instructions.
2. Keep the documentation close to the measuring instrument ready for quick reference.
3. Follow all safety precautions, accident prevention regulations and internal company rules and guidelines. If necessary you should request further information from your company safety officer.
4. Before connecting up this measuring instrument, please check the local mains supply voltage to ensure that it is within the working range of the AC adaptor (100 V - 240 V, 50 Hz - 60 Hz).
If they do not match, this measuring instrument must not be connected under any circumstances!
5. The instrument may only be connected to a grounded power socket which complies with the regulations of the local power supply company.
This also applies to any extension cables that are used.
6. Only use original and intact AC adapters.
7. When connecting inductive probes ensure that the plugs are firmly screwed onto the connection sockets.
8. Do not drop the instrument and make sure it is positioned securely.
9. Do not operate the instrument in areas where there is a risk of explosion and do not expose it to direct sunlight!
10. Do not clean the membrane keypad with solvent-based cleaning agents.
11. The instrument must not be opened.
12. The test and measuring equipment, for which the Millimar is used, is subject to inspection equipment monitoring.
For this reason, regular inspection equipment monitoring performed by either the user or Mahr Service must ensure compliance with the specified error limits for the test and measuring equipment.

Important notes prior to using the length measuring instrument

- The measuring instrument may only be used for its intended purpose. No liability will be accepted for damages caused by other usage or as a result of the incorrect application of this measuring instrument.
- Should your measuring task not be solved with this measuring instrument, we can offer you another solution from our product range. Please provide us with details of your measuring task.

! Do not use an electric marking tool.

Disposal information

Electronic equipment which was purchased from Mahr after March 23, 2006 can be returned to us. We will dispose of this equipment in an environmentally-friendly way.

The valid EU directives (WEEE, ElektroG) apply.

Confirmation of traceability

We declare, with sole responsibility, that this product conforms with standards and technical data as specified in our sales documents (operating instructions, leaflet, catalog). We certify that the testing equipment used to check this product, and guaranteed by our Quality Assurance, is traceable to national standards.

Thank you for placing your trust in us by purchasing this product.

EC Declaration of Conformity

This instrument complies with the applicable EU directives.



The most up-to-date Declaration of Conformity can be downloaded at:
www.mahr.com/products, on the product page.

Order no.	Last modification	Version
3723010	07/26/2021	Valid from firmware version 1.0.0.1

Table of contents

1	Delivery and connection	8
1.1	Unpacking.....	8
1.2	Scope of delivery.....	10
1.3	Using the measuring module	11
1.4	Symbols	12
1.5	Operating elements and interfaces.....	14
1.5.1	Display and operating keys.....	14
1.5.2	Keys with dual function	15
1.5.3	Mode display for master measurement	16
1.5.4	Ports.....	16
2	Initial operation	17
2.1	Switching ON	17
2.2	Selecting the display language.....	17
2.3	Setting the measurement unit.....	17
2.4	Connecting the measuring probe.....	18
2.5	Selecting the probe type	18
2.6	Setting up the probe.....	20
2.7	Measuring screen	21
2.8	Switching OFF	21
3	Configuring the Feature menu	22
3.1	Select feature	22
3.2	Configuring the feature.....	22
3.2.1	Formula.....	22
3.2.1.1	Factor	23
3.2.1.2	Function	24
3.2.1.3	Connection.....	26
3.2.1.4	Divisor	27

3.2.2	Master.....	29
3.2.2.1	One-point master measurement.....	29
3.2.2.2	Two-point master measurement.....	30
3.2.3	Nominal value.....	34
3.2.4	Tolerance.....	35
3.2.5	Warning limits.....	38
3.2.6	Resolution.....	41
3.2.6.1	Length resolution.....	41
3.2.6.2	Resolution angle.....	42
3.2.7	Name.....	42
3.2.8	Display style.....	43
3.2.9	Display center at.....	45
4	Display menu.....	46
4.1	Brightness.....	46
4.2	Screensaver.....	46
5	Setup.....	47
5.1	Setup 1.....	47
5.1.1	Feature selection.....	47
5.1.2	Unit length.....	48
5.1.3	Unit angle.....	48
5.1.4	Master measurement mode.....	49
5.1.5	Number of masters.....	50
5.1.6	Master reset.....	50
5.2	Setup 2.....	51
5.2.1	Foot switch (switching input).....	51
5.2.2	Sending data.....	53
5.2.3	Work mode.....	54
5.2.4	Measuring time.....	56
5.2.5	Break time.....	57
5.2.6	Start delay.....	58
5.3	Setup 3.....	60
5.3.1	Factor C1.....	60
5.3.2	Factor C2.....	60

5.3.3	Probe type C1	61
5.3.4	Probe type C2	61
5.3.5	Filters (Average of n-values).....	62
6	System	63
6.1	System 1	63
6.1.1	Setting up the transducer	63
6.1.2	Calibration.....	64
6.1.2.1	Calibration C1	64
6.1.2.1.1	Customer calibration activation	64
6.1.2.1.2	Performing customer calibration	65
6.1.2.1.3	Activating a factory calibration.....	68
6.1.2.2	Correction C2.....	68
6.1.2.3	Symmetry C1 to C2.....	69
6.1.3	Factory settings.....	72
6.1.4	Menu interlock.....	73
6.1.5	Info	75
6.1.6	Selecting the language	75
6.2	System 2	76
6.2.1	Updating module N 1700.....	76
6.2.2	Managing parameters.....	77
6.2.3	Miscellaneous	79
6.2.4	Service	80
7	Description of the interfaces.....	81
7.1	Compatible data cables.....	81
7.2	Data transmission parameters.....	82
8	Technical data	84
8.1	Compact length measuring instrument Millimar C 1202	84
8.2	Compatible probes for the Millimar C 1202	86
9	Accessories.....	88
9.1	Compatible N 1700 measuring modules.....	88
9.2	Other accessories	88

1 Delivery and connection

1.1 Unpacking

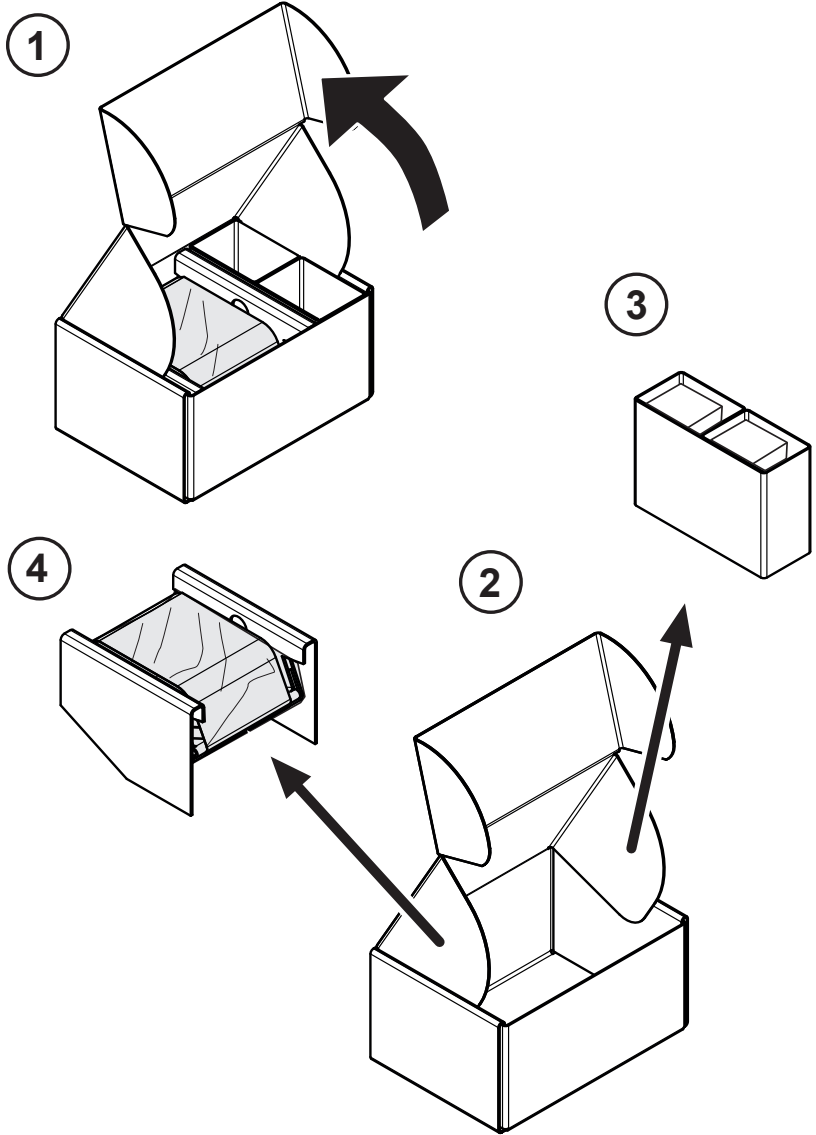

5

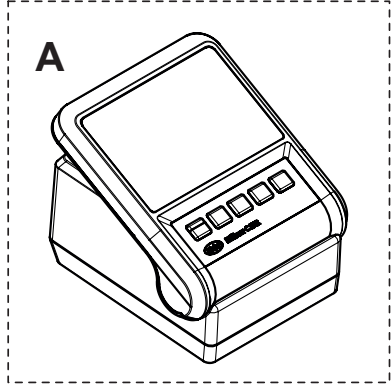
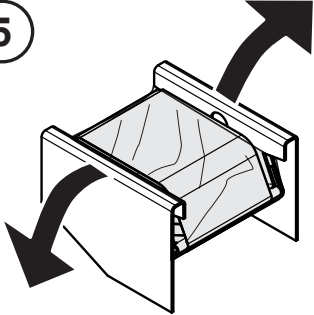

6

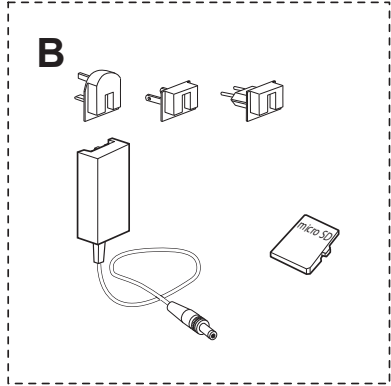
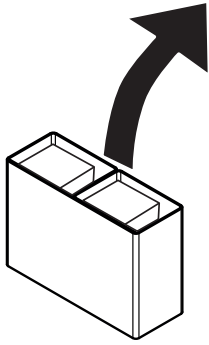

1.2 Scope of delivery

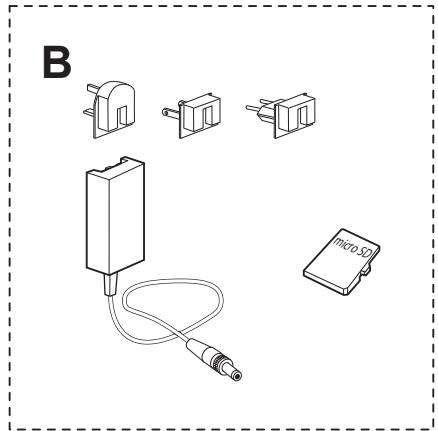
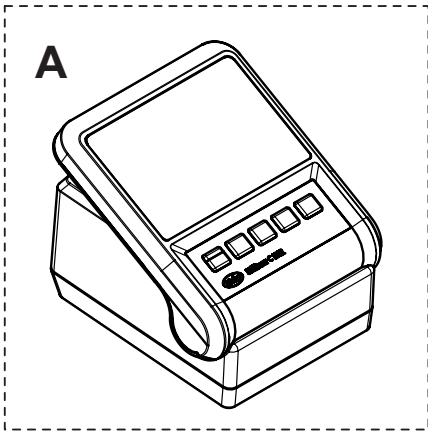

Scope of delivery

- Millimar C 1202
- Power supply unit with interchangeable adapter
- Bus termination module
- Micro SD memory card
- Quick guide

Bus termination module fitted in C 1202

Slot for Micro SD memory card

1.3 Using the measuring module



**Measuring module N 1700 is not included with delivery of the C 1202.
A measuring module is required to operate the C 1202.**

- Slide measuring module N 1700 with bus termination module onto the rail as far as the stop.
- Push the two red slide catches down so that the measuring module and the bus termination module cannot come out accidentally.



Measuring module N1700 is removed in the reverse order.

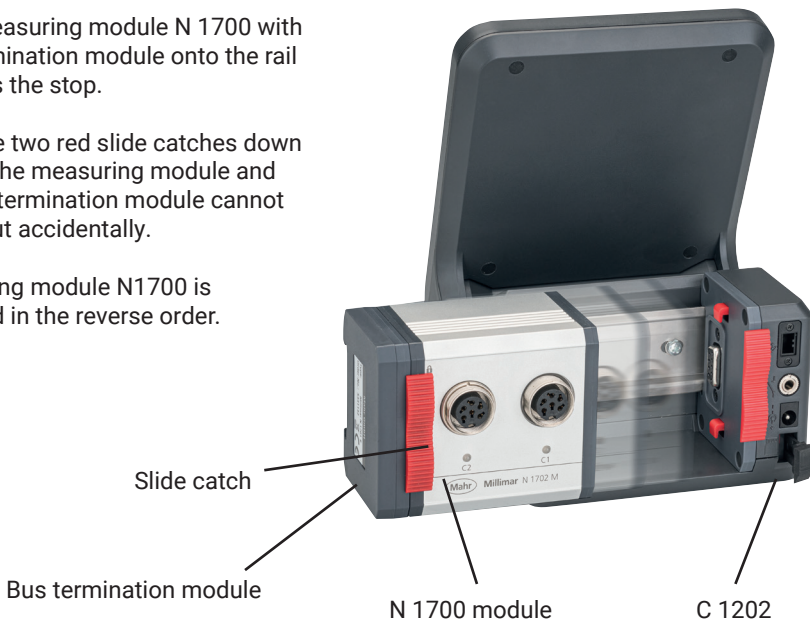



















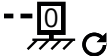





Compatible N 1700 measuring modules:

5331120	Millimar N 1702 M	Module for 2 inductive probes
5331121	Millimar N 1702 T	Module for 2 inductive probes
5331122	Millimar N 1702 U	Module for 2 inductive probes
5331125	Millimar N 1702 M-HR	Module for 2 inductive probes
5331161	Millimar N 1702 Vss *	Module for 2 incremental probes
5331150	Millimar N 1701 PM-2500	Module for 1 pneumatic measuring instrument
5331151	Millimar N 1701 PM-5000	Module for 1 pneumatic measuring instrument
5331152	Millimar N 1701 PM-10000	Module for 1 pneumatic measuring instrument
5331155	Millimar N 1701 PF-2500/5000	Module for 1 pneumatic measuring instrument
5331156	Millimar N 1701 PF-PF25/.50. 4-J	Module for 1 pneumatic measuring instrument
5331157	Millimar N 1701 PF-10000	Module for 1 pneumatic measuring instrument



**Up to two N 1701 PM and N 1701 PF measuring modules can be used at the same time.
* from firmware C 1202 version 1.1.0.0**

1.4 Symbols

Start screen			
	Select menu		
	Set zero point		
	Set zero point manual		
	Set zero point sequential		
	Set zero point parallel		
	Set zero point. Hold down Toggle function		Reset max, min memory. Hold down Toggle function
	Set zero point manual Hold down Toggle function		Reset max, min memory manual Hold down Toggle function
	Set zero point sequential Hold down Toggle function		Reset max, min memory sequential Hold down Toggle function
	Set zero point parallel Hold down Toggle function		Reset max, min memory parallel Hold down Toggle function
	Data transfer disabled, no connection		Data transfer
	Data transfer Manual, disabled		Data transfer manual
	Data transfer Sequential, disabled		Data transfer sequential
	Data transfer Parallel, disabled		Data transfer parallel
	Reduce the resolution		Increase the resolution
	Reduce the resolution Hold down Toggle function		Increase the resolution Hold down Toggle function
	Selecting a feature		

Settings menu			
	Select menu		Exit menu
	Scroll to the left		Scroll to the right
	Scroll down		Scroll up
	Select submenu		
	Confirm selection/entry		Cancel submenu/entry
	Select item		Deselect item
	Save settings to memory card		Delete file from memory card
"Time controlled" measuring mode			
	Start measurement		
	Pause measurement		Stop measurement
	Reset max, min memory.		
	Select feature Hold down Toggle function		Select feature disabled Hold down Toggle function
	Start measurement Hold down Toggle function		

1.5 Operating elements and interfaces

1.5.1 Display and operating keys

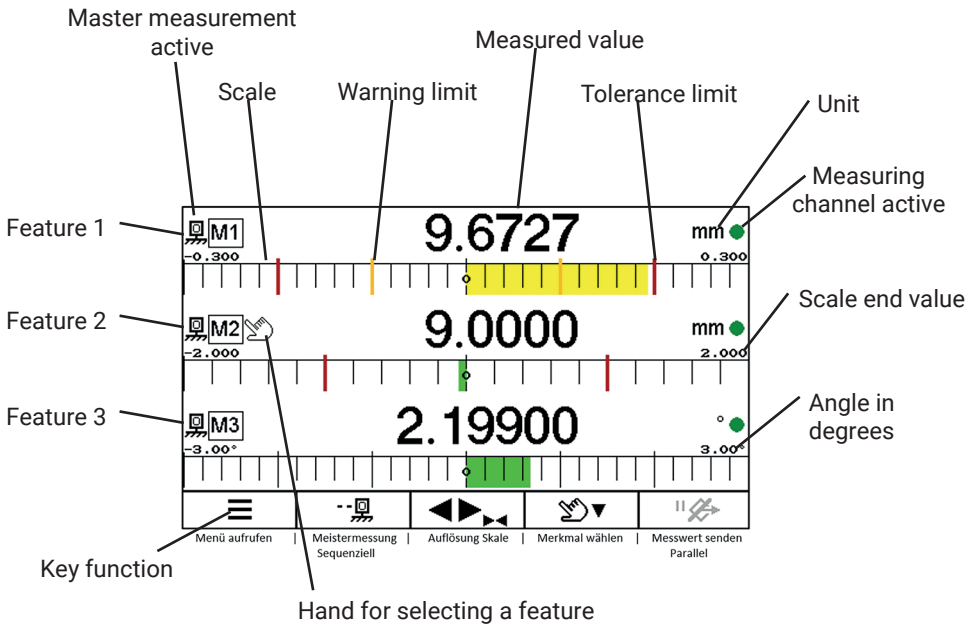

1.5.2 Keys with dual function

 Some keys have two functions.
Pressing the key for longer than two seconds toggles the function.

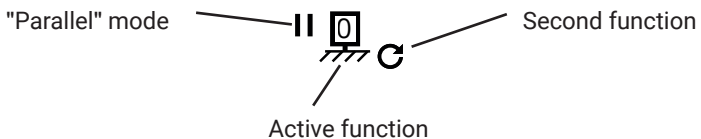

Increase scale resolution



Reduce scale resolution



Hand, select feature



Start measurement in
time controlled mode



Master measurement



Reset extreme value memory

1.5.3 Mode display for master measurement

Manual mode

=> Master measurement is performed for the feature at which the hand is pointing



Sequential mode

=> Master measurement is performed for the feature at which the hand is pointing. Hand switches automatically to next feature. The master measurement can now be performed for this feature.



Parallel mode

=> Master measurement is performed for all active features at the same time.



1.5.4 Ports

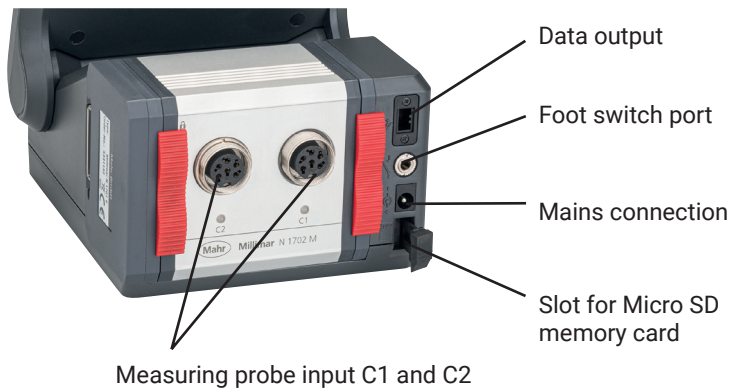

2 Initial operation



2.1 Switching ON

- Connect the mains adapter to the measuring instrument and mains socket
 - Press the ON / OFF key
- => The following appears on the display:

Start screen

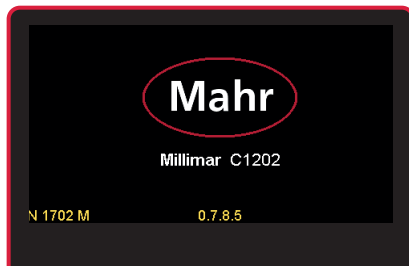

2.2 Selecting the display language

- Select the relevant language with ▼ or ▲
- Confirm entry by pressing key ✓

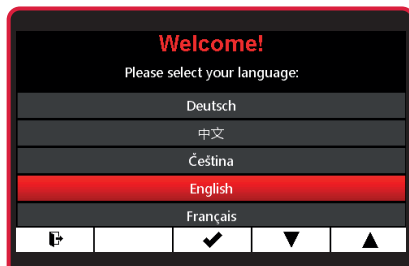

2.3 Setting the measurement unit

- Select the relevant measuring unit with ▼ or ▲
- Confirm entry by pressing key ✓

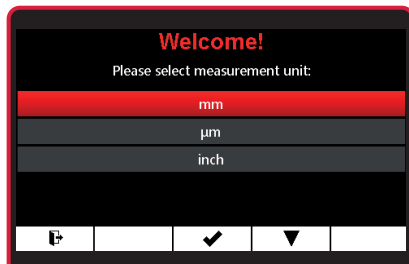

2.4 Connecting the measuring probe

- Connect the measuring probe to probe input C1



Probe input C1 and C2

2.5 Selecting the probe type

Press the ON/OFF key

- => Menu appears



- Select **Setup 3** with ► or ◀ and 

Feature M1	Display	Setup 3	System 1
Factor C1			1.0000
Factor C2			1.0000
Probe type C1			Mahr, Standard
Probe type C2			Mahr, Standard
Filter (Average of n-values)			1

- Select submenu **Probe type C1** with ▼ or ▲
- Select using ✓ key or exit submenu using ✕ key

Feature M1	Display	Setup 3	System 1
Factor C1			1.0000
Factor C2			1.0000
Probe type C1			Mahr, Standard
Probe type C2			Mahr, Standard
Filter (Average of n-values)			1

- Select the relevant measuring probe type using ▼ or ▲
- => See Technical Data in the operating instructions for compatible measuring probes.
- Confirm entry by pressing ✓ key or cancel with ✕ key
- Exit submenu with ✕ or exit the settings menu by pressing the ↩ key.

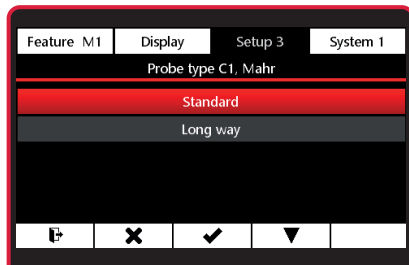

! *The instrument is most accurate after approx. 30 minutes of operation. Inductive measuring probes should be mechanically set to the electrical zero point before the first measurement. To do this, use the Absolute mode that indicates the raw value or absolute value of the probe.*

2.6 Setting up the probe

- Press the ON/OFF key
- => Menu appears
- Select **System 1** with ► or ◀ and 
- Select **Absolute mode** with ▼
- Confirm entry with ✓ key or exit submenu with ✕ key

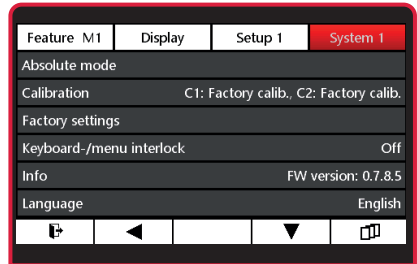

 One or two measuring channels will appear. Depends on N 1700 module used. The value displayed is the direct value from the measuring sensor.

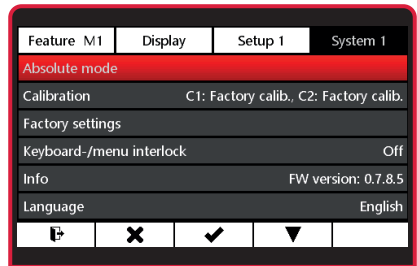

- Adjust measuring probe mechanically close to "0"
- The scaling can be adjusted with the ► ◀ or ◀ ► key
- Exit the settings menu by pressing the  key.

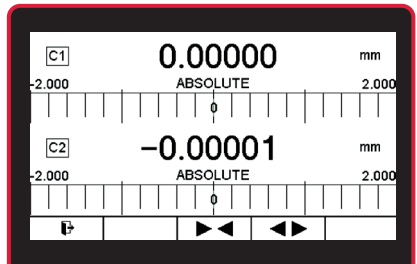

2.7 Measuring screen

- Press the ON/OFF key
- => Measuring screen appears
- Display value can be set to master value with  key
- => Master value = 0

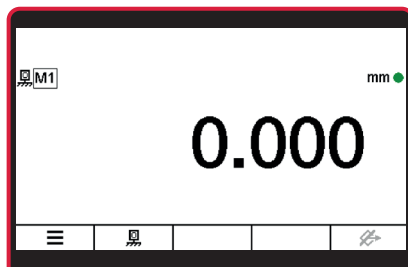
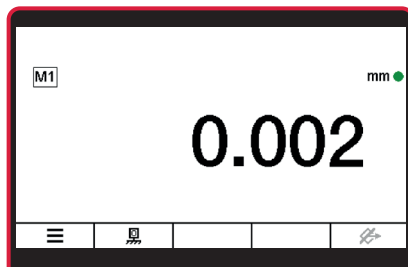

2.8 Switching OFF

- ! The measuring screen must be active to switch off the C1202 using the ON/OFF key.
- Press ON/OFF key for at least 2 seconds. The instrument switches off.

 The full operating instructions can be downloaded at: www.mahr.com/products, on the product page.

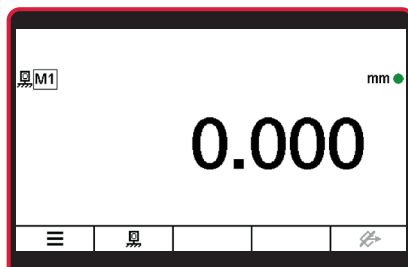





3 Configuring the feature menu

3.1 Select feature

- Press the ON/OFF key
=> Menu appears
 - Use the ✖ key, ▶ or ◀ and  to select the **Feature (M1 / M2 / M3)** you wish to configure.
- ! Only the active features will appear on the measuring screen.
See Section 5.1.1 Setup 1 / Feature selection









Feature M1	Display	Setup 1	System 1
Formula	1.0000 x ((+ C1) / 1.0000)		
Master	0.000 mm		
Nominal value	0.000 mm		
Tolerance	Off		
Warning limits	Off		
Resolution length	0.001 mm		
    			

3.2 Configuring the feature

3.2.1 Formula

- Select the Formula submenu using the ▼ or ▲ key
 - Select using ✓ key or exit submenu using ✖ key.
- => The formula editor appears
- Press the ▼ key to edit the formula.
Factor is selected.

Feature M1	Display	Setup 1	System 1
Formula	1.0000 x ((+ C1) / 1.0000)		
Master	0.000 mm		
Nominal value	0.000 mm		
Tolerance	Off		
Warning limits	Off		
Resolution length	0.001 mm		
    			

Feature M1	Display	Setup 1	System 1
Formula			
Factor	Function	Connector	Divisor
1.0000	x	((+ C1)	/ 1.0000)
 			

3.2.1.1 Factor

- Use the **✓** key to select the **Factor** submenu.
- Use the **▶** key to select the digit and the **▼** or **▲** key to enter the relevant value.
- Use the **✓** key to confirm the value or **✘** to exit the submenu.
- Use **▶** to select **Function** or **▲** or **✘** to finish editing the formula and  to accept changes or **✘** to exit the formula editor without applying the changes.



If a value is changed but the change has not yet been saved, the "Formula" text appears in gray. The changed formula can only be saved when the row with "Formula" appears in red.

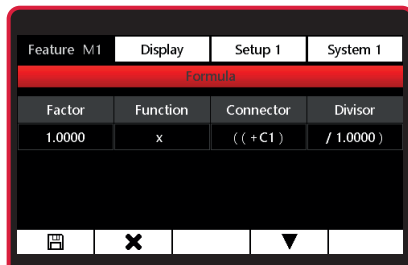
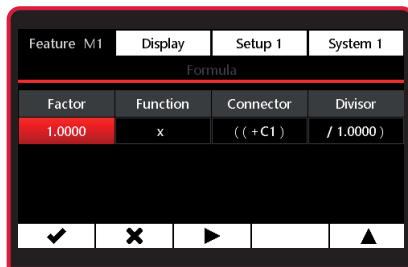
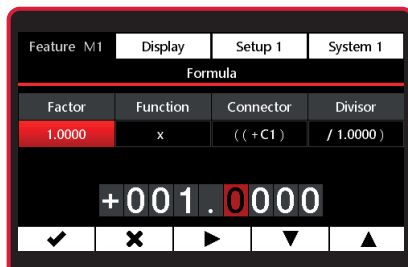
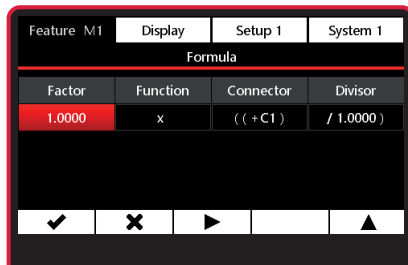

3.2.1.2 Function

- Use the **✓** key to select the **Function** submenu.

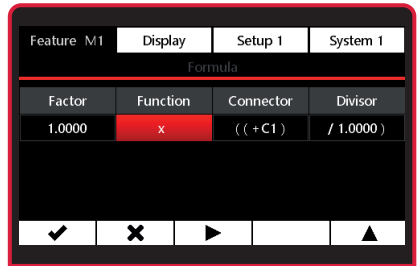

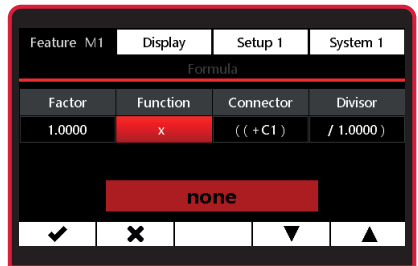

- Use the **▲** or **▼** key to select the relevant function.

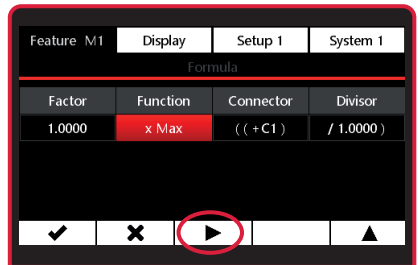

- Use the **✓** key to confirm the function or **x** to exit the submenu.

- Use **▶** to select **Connector** or the **▲** or **x** key to finish editing Formula



and  to accept changes or **x** to exit the Formula Editor without applying the changes.

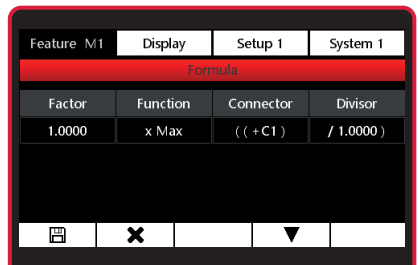

Possible functions:

None (shown as x in the formula)

Current measuring value that is calculated from the selected linking formula is always displayed.

Max

Greatest measuring value (maximum value) is always shown. The value displayed only changes if the currently valid maximum value is exceeded.

Min

Lowest measuring value (minimum value) is always shown. The value displayed only changes if that value is less than currently valid minimum value.

(Max+Min)/2

The sum of the lowest value measured so far (minimum value) and the highest value measured so far (maximum value) divided by 2 is always shown. The value displayed only changes if a value less than the currently valid minimum value is recorded or if the currently valid maximum value is exceeded. This function is used to calculate the mean of the maximum value and the minimum value.

Average

The average of all of the previously measured single values is always shown. The average value is calculated using the following formula: (measuring value 1 + measuring value 2 + + measuring value x) / (Number x) of single measuring values.

Max-Min

The difference between the lowest value measured so far (minimum value) and the greatest value measured so far (maximum value) is always shown. The value displayed only changes if a value less than the currently valid minimum value is recorded or if the currently valid maximum value is exceeded.

atan (inverse tangent)

This function is used to calculate angles, e.g. a cone angle. The inverse tangent is calculated from the selected linking formula. The result can be displayed according to the unit selected: degrees, degrees/min´/sec´´ or Rad.

3.2.1.3 Connection

- Use the **✓** key to select the **Connector** submenu.
- Use the **▲** or **▼** key to select the relevant function.
- Use the **✓** key to confirm the function or **✕** to exit the submenu.

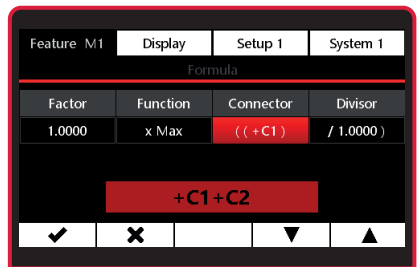
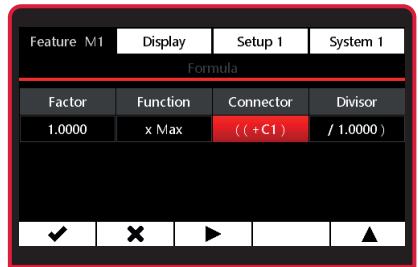

The options are:

- +C1 Raw value of transducer at measuring channel C1
- C1 inverted raw value of transducer at measuring channel C1
- +C2 Raw value of transducer at measuring channel C2
- C2 inverted raw value of transducer at measuring channel C2
- +C1 + C2 Sum of transducer raw values at measuring channels C1 and C2
- +C1 - C2 Difference of the raw values. If $C2 < C1$, the difference is positive; if $C2 > C1$, it is negative
- +C2 - C1 Difference of the raw values. If $C2 > C1$, the difference is positive; if $C2 < C1$, it is negative
- C1-C2 Difference between the two inverted raw values of the transducers at measuring channels C1 and C2

- Use ► to select **Divisor** or the ▲ or ✖ key to finish editing Formula

and  to accept changes or ✖ to exit the Formula Editor without applying the changes.

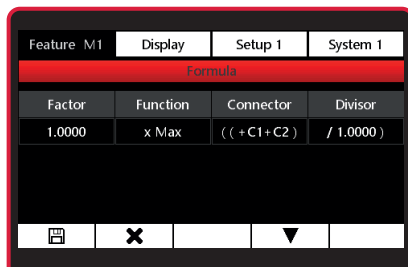
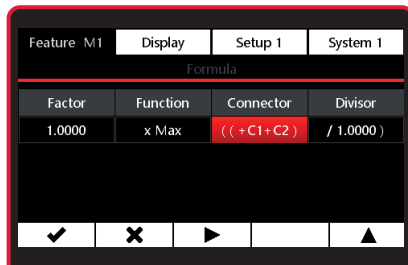

3.2.1.4 Divisor

- Use the ✓ key to select the **Divisor** submenu.
- Use the ► key to select the digit and the ▲ or ▼ key to enter the relevant value.
- Use the ✓ key to confirm the value or ✖ to exit the submenu.

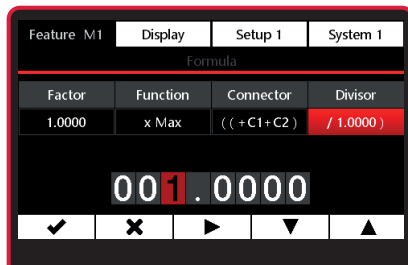
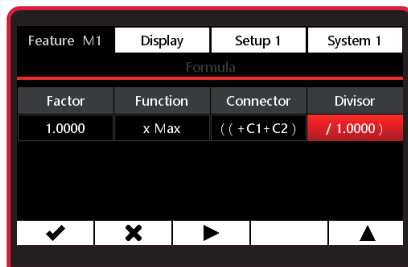

- Use **▶** to select **Factor** or the **▲** or **✘** key to finish editing Formula.

and **☰** to accept changes or **✘** to exit the Formula Editor without applying the changes.

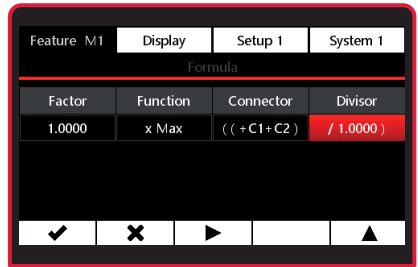

- Use the **☰** key to switch to measuring mode or **✘** to exit the **Feature** submenu or **☑** to edit **Formula** or **▲**, **▼** to scroll through the submenu.

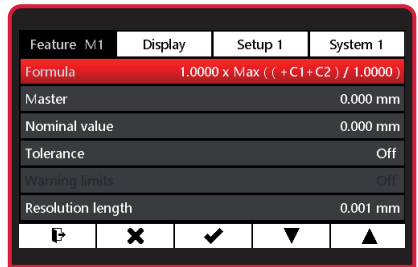
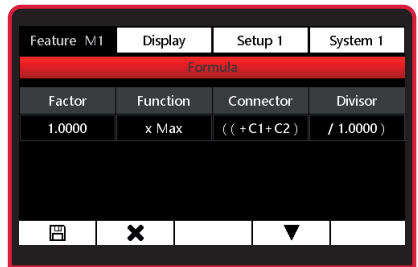



3.2.2 Master

Measurements performed with just one transducer are generally comparative measurements, i.e. the deviations from a nominal value are measured and displayed. These nominal values are determined using measurements on gage blocks, setting plugs or special workpieces with known dimensions, known as "master workpieces" or "masters" for short. These master measurements are performed before beginning the actual measurement. There are one point and two point master measurements. See Section 5.1.5., Setup 1, Number of masters for setting one-point and two-point master measurements

3.2.2.1 One-point master measurement

Only one master (gage block) is contacted in a one-point master measurement, and the displayed value is compared with the entered nominal value. This determines if the actual value just measured deviates from the nominal value and if so, by how much. It is assumed that the deviation determined here is constant across the entire measuring range and corrects the raw values of the subsequent workpiece measurements by the amount determined here before the measuring results are displayed. If the actual value displayed is + 10µm greater than the nominal value of the master, the raw values of all of the subsequent workpiece measurements are reduced by 10µm and the corrected value is displayed as the measuring result. The characteristic curve of the probe is thus shifted accordingly (in parallel) in the display range.

- Press the ON/OFF key
=> Menu appears.
- Use the ✖ key, ▶ or ◀ and  to select the **Feature (M1 / M2 / M3)** you wish to configure.
- Select the **Master** submenu using the ▼ or ▲ key.
- Select using ✓ key or exit submenu using ✖ key.
- Use the ▶ key to select the digit and the ▼ or ▲ keys to enter the relevant value.
- Use the ✓ key to confirm the value or ✖ to exit the submenu.
- Use the  key to switch to measuring mode.

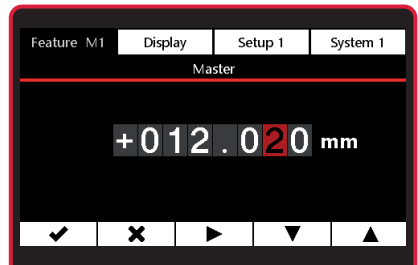
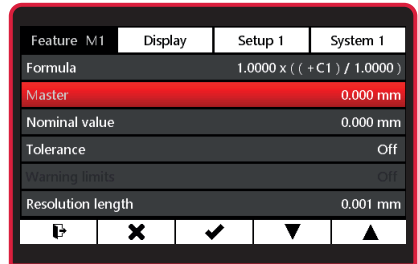

3.2.2.2 Two-point master measurement

In a two-point master measurement, two masters (gauge blocks) of different sizes are contacted in sequence and the actual values displayed are compared with the nominal values indicated on the masters.

First, as for the one-point master measurement, the deviation from the nominal value is calculated from the measurement on the first (smaller) gauge block and then corrected. The characteristic curve of the probe is thus shifted accordingly again in the display range (in parallel) in the first step.

In a second step, a correction factor is calculated from the difference between the two nominal values (max master - min master). This factor is used to change the pitch of the characteristic curve of the probe in a linear fashion.

- Press the ON/OFF key
=> Menu appears.



- Use the ✕ key, ▶ or ◀ and  to select the **Feature (M1 / M2 / M3)** you wish to configure.

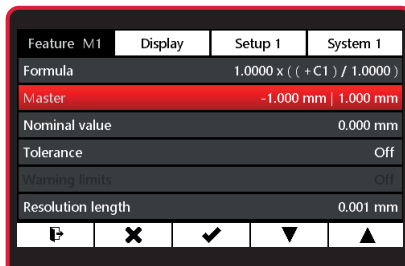

- Select the **Master** submenu using the ▼ or ▲ key.

- Select using ✓ key or exit submenu using ✕ key.

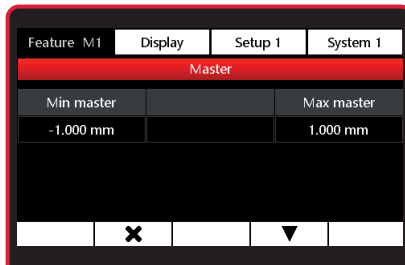

- Press the ▼ to edit the values for **Min master** and **Max master**.

- Use the ✓ key to select the **Min master** submenu.

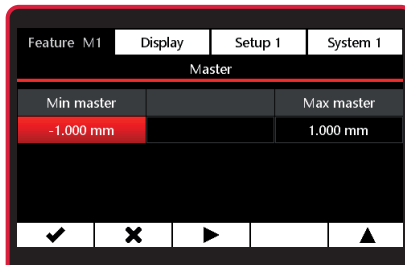

- Use the ► key to select the digit and the ▼ or ▲ keys to enter the relevant value.
- Use the ✓ key to confirm the value or ✕ to exit the submenu.

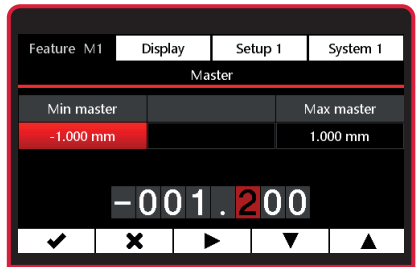

- Use ► to select **Max master** or the ▲ or ✕ key to finish editing Master value

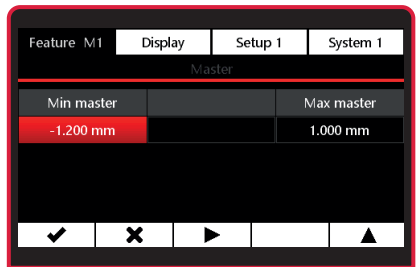

and [Save] to accept changes or ✕ to exit the Master Value Editor without applying the changes.

- Use the ✓ key to select the **Max master** submenu.
- Use the ► key to select the digit and the ▼ or ▲ keys to enter the relevant value.
- Use the ✓ key to confirm the value or ✕ to exit the submenu.

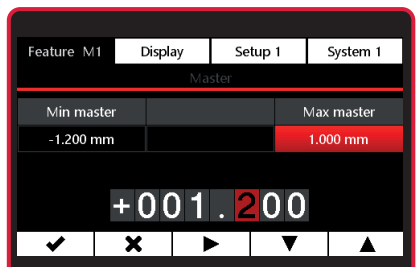

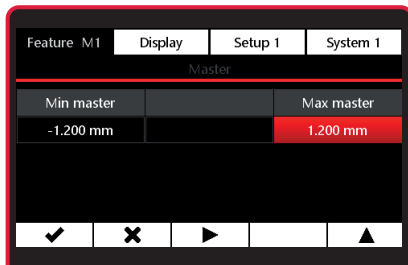

- Use ► to select **Min master** or the ▲ or ✕ key to finish editing **Formula**

and  to accept changes or ✕ to exit the Formula Editor without applying the changes.

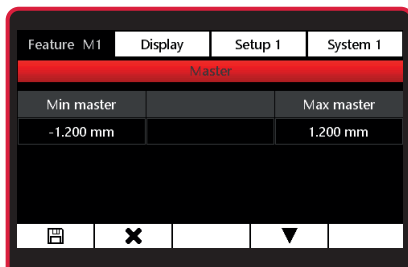

-  If a value is changed but the change has not yet been saved, the "Master" text appears in gray. The changed master values can only be saved when the row with "Master" appears in red.



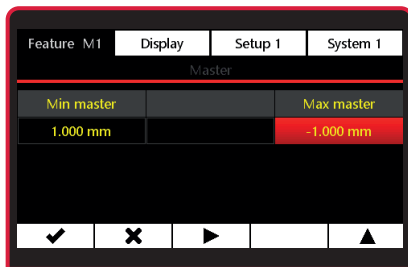

-  If a greater number is entered for Min master than for Max master, the numbers will appear in yellow. The entries cannot be saved.

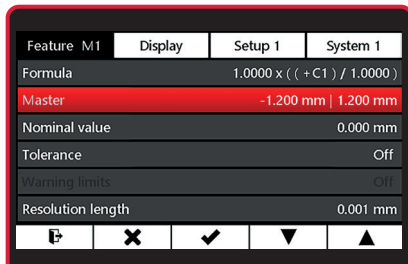

- Use the  key to switch to measuring mode or ✕ to exit the Feature submenu or ✓ to edit the master or ▼, ▲ to scroll through the submenu.



3.2.3 Nominal value

- Press the ON/OFF key
=> Menu appears.
- Use the ✖ key, ▶ or ◀ and  to select the **Feature (M1 / M2 / M3)** you wish to configure.
- Select the **Nominal value** submenu using the ▼ or ▲ key.
- Select using ✓ key or exit submenu using ✖ key.
- Use the ▶ key to select the digit and the ▼ or ▲ keys to enter the relevant value.
- Use the ✓ key to confirm the value or ✖ to exit the submenu.
- Use the  key to switch to measuring mode.
or ✖ to exit the **Feature** submenu
or ✓ to edit the **Nominal value**
or ▼, ▲ to scroll through the submenu.

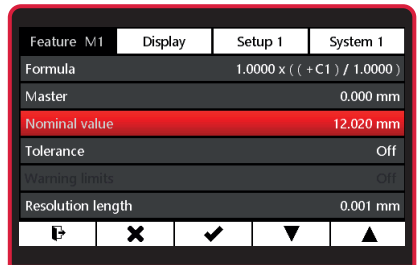
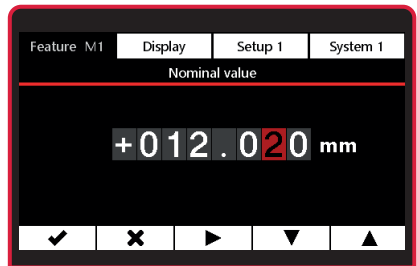
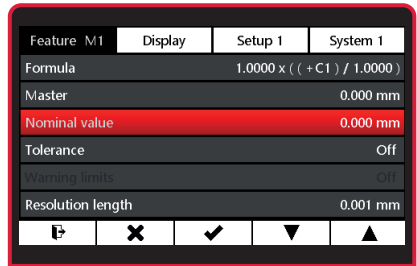

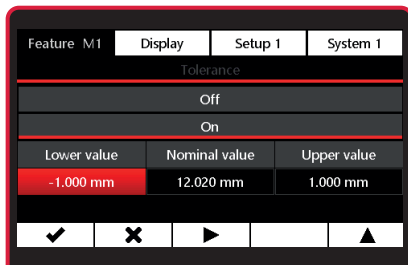
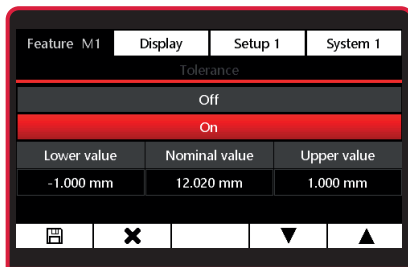
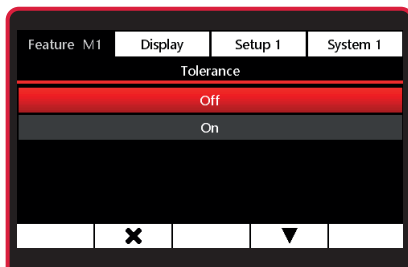
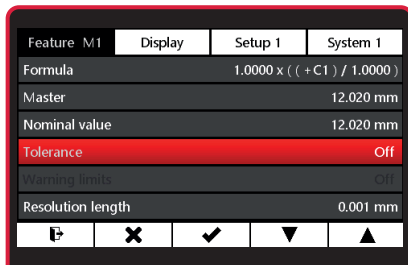

3.2.4 Tolerance

- Press the ON/OFF key
=> Menu appears.
- Use the ✕ key, ► or ◀ and  to select the **Feature (M1 / M2 / M3)** you wish to configure.
- Select the **Tolerance** submenu using the ▼ or ▲ key.
- Select using ✓ key or exit submenu using ✕ key.
- Press ▼ to activate the tolerance evaluation
- Press ▼ to edit the values for **Lower value** and **Upper value**.
- Use the ✓ key to select the **Lower value** submenu.



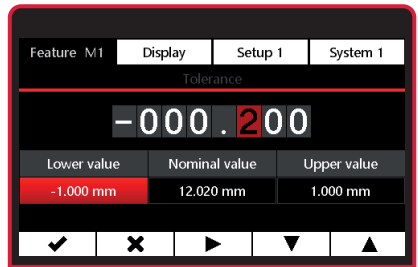

- Use the ► key to select the digit and the ▼ or ▲ keys to enter the relevant value.
- Use the ✓ key to confirm the value or ✕ to exit the submenu.

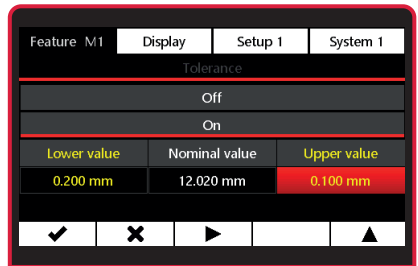

 Tolerance values for the lower value and the upper value must be entered relative to the nominal size.

 If a greater number is entered for the lower value than for the upper value, the numbers will appear in yellow. The entries cannot be saved.



- Use ► to select **Upper value** or ▲ or ✕ to finish editing the **tolerance** and  to accept changes, or ✕ to exit the Tolerance Editor without saving the changes.

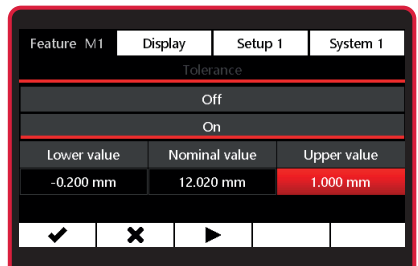

- Use the **✓** key to select the **Upper value** submenu.
- Use the **▶** key to select the digit and the **▼** or **▲** key to enter the relevant value.
- Use the **✓** key to confirm the value or **✘** to exit the submenu.
- Use **▶** to select **Lower value** or **▲** or **✘** to finish editing **Tolerance**

and **☰** to accept changes or **✘** to exit the Tolerance Editor without applying the changes.

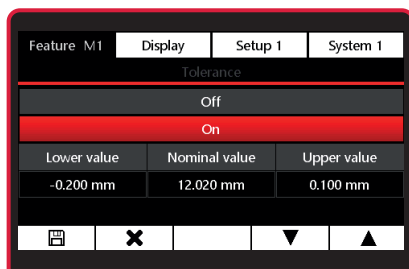
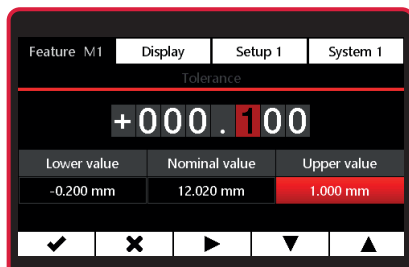

- Use the **↔** key to switch to measuring mode or **✘** to exit the Feature submenu or **✓** to edit the tolerance or **▼**, **▲** to scroll through the submenu.

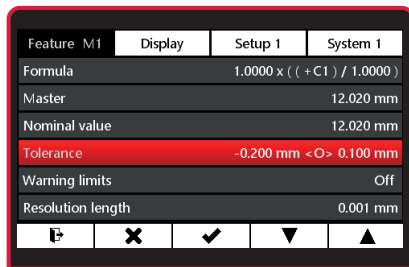

☞ If a tolerance value is changed but the change has not yet been saved, the "Tolerance" text appears in gray. The changed tolerance values can only be saved when the row with "On" or "Off" appears in red.

3.2.5 Warning limits

- Press the ON/OFF key
=> Menu appears.
- Use the ✕ key, ► or ◀ and  to select the **Feature (M1 / M2 / M3)** you wish to configure.
- Select the **Warning limits** submenu using the ▲ or ▼ key.
- Select using ✓ key or exit submenu using the ✕ key.
- Press ▼ to activate the warning limits
- Press ▼ to edit the values for **Lower value** and **Upper value**.
- Use the ✓ key to select the **Lower value** submenu.

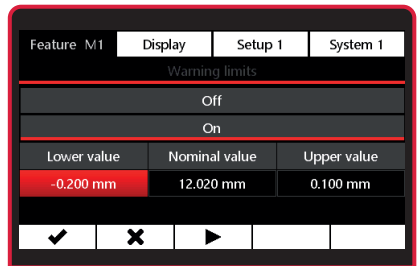
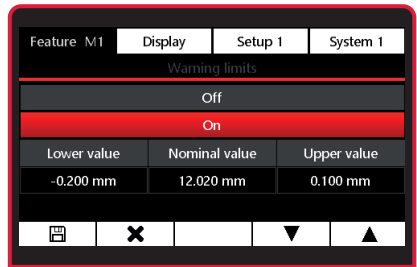
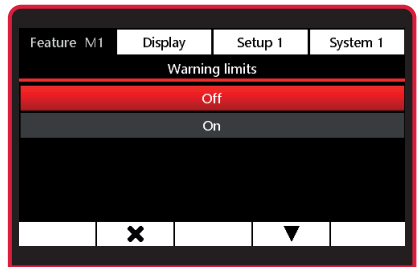
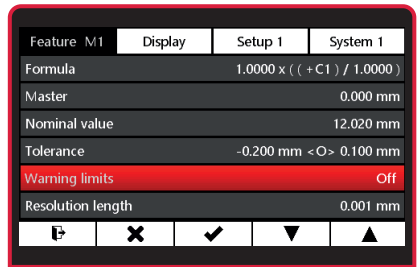

- Use the ► key to select the digit and the ▼ or ▲ key to enter the relevant value.
- Use the ✓ key to confirm the value or ✕ to exit the submenu.

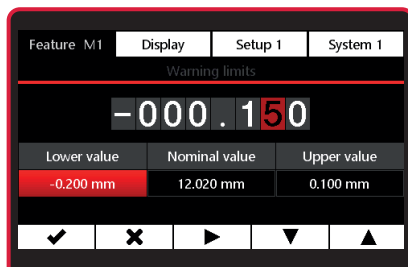

 Values for the lower value and the upper value must be entered relative to the nominal size.

 If a greater number is entered for the lower value than for the upper value, the numbers will appear in yellow. The entries cannot be saved.

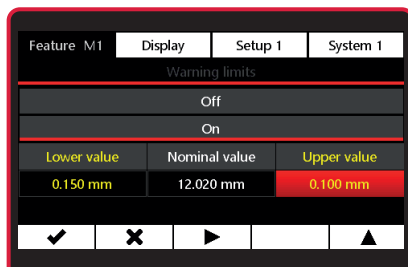

- Use ► to select **Upper value** or ▲ or ✕ to finish editing **Warning limits**

and  to accept changes or ✕ to exit the **Warning limits** Editor without applying the changes.

- Use the ✓ key to select the **Upper value** submenu.

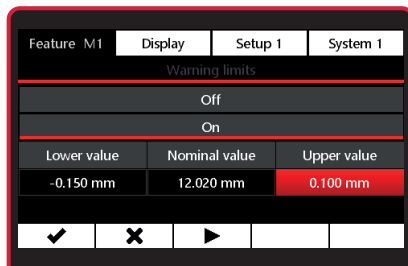

- Use the ► key to select the digit and the ▼ or ▲ key to enter the relevant value.
- Use the ✓ key to confirm the value or ✘ to exit the submenu.
- Use ► to select **Lower value** or ▲ or ✘ to finish editing the **Warning limits**

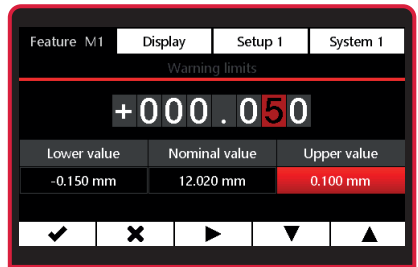

and to accept changes or ✘ to exit the **Warning limits** Editor without applying the changes.

- Use the key to switch to measuring mode or ✘ to exit the Feature submenu or ✓ to edit the **Warning limits** or ▼, ▲ to scroll through the submenu.

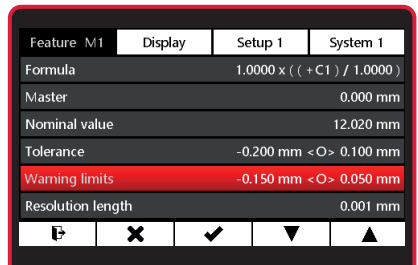
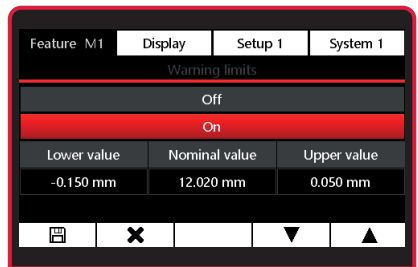

If a warning limit is changed but the change has not yet been saved, the "Warning limits" text appears in gray. The changed warning limits can only be saved when the row with "On" or "Off" appears in red.

3.2.6 Resolution

You can select the resolution for the measuring value display according to the function in the formula.

Resolution length for function (x, Max, Min, (Max+Min)/2, average, Max-Min)

Resolution angle for function (atan)

- Press the ON/OFF key
=> Menu appears.
- Use the **X** key, **▶** or **◀** and to select the **Feature (M1 / M2 / M3)** you wish to configure.

3.2.6.1 Resolution length

- Select the **Resolution length** submenu using the **▼** or **▲** key.
- Select using **✓** key or exit submenu using the **X** key.
- Use the **▲** or **▼** key to select the relevant resolution.
- Use the **✓** key to confirm the selection or **X** to exit the submenu. Use the key to switch to measuring mode.

Feature M1	Display	Setup 1	System 1
Formula	1.0000 x Max ((+C1+ C2) / 1.0000)		
Master	12.020 mm		
Nominal value	12.020 mm		
Tolerance	-0.200 mm <O> 0.100 mm		
Warning limits	-0.150 mm <O> 0.050 mm		
Resolution length	0.001 mm		

Feature M1	Display	Setup 1	System 1
Resolution length			
0.01 mm			
0.001 mm			
0.0001 mm			

3.2.6.2 Resolution angle

- Select the **Resolution angle** submenu using the ▼ or ▲ key.
- Select using ✓ key or exit submenu using ✕ key.
- Use the ▲ or ▼ key to select the relevant resolution.
- Use the ✓ key to confirm the selection or ✕ to exit the submenu. Use the ↵ key to switch to measuring mode.

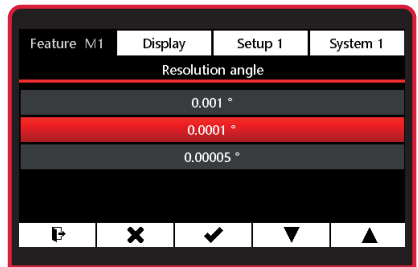
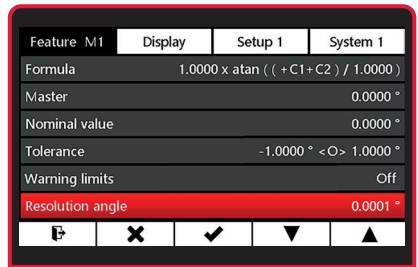



3.2.7 Name

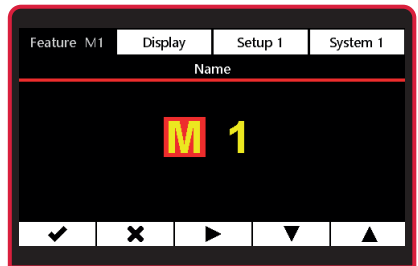
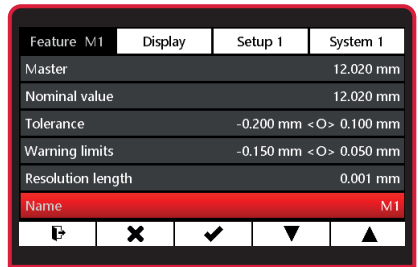



- Press the ON/OFF key => Menu appears.
- Use the ✕ key, ► or ◀ and  to select the **Feature (M1 / M2 / M3)** you wish to configure.
- Select the **Name** submenu using the ▼ or ▲ key.
- Select using ✓ key or exit submenu using ✕ key.
- Use the ▲ or ▼ key to select the relevant letter. A – Z is possible.
- Use the ► key to select **Number**.







- Use the ▲ or ▼ key to select the relevant number. (0 – 9) is possible.
- Use the ✓ key to confirm the selection or ✕ to exit the submenu.

3.2.8 Display style

- Press the ON/OFF key
=> Menu appears.
- Use the ✕ key, ► or ◀ and  to select the **Feature (M1 / M2 / M3)** you wish to configure.
- Select the **Display style** submenu using the ▼ or ▲ key.
- Select using ✓ key or exit submenu using the ✕ key.
- Use the ▲ or ▼ key to select the relevant display style.
- Use the ✓ key to confirm the selection or ✕ to exit the submenu.
Use the  key to switch to measuring mode.

Feature D1	Display	Setup 1	System 1
Nominal value			12.020 mm
Tolerance			-0.200 mm <O> 0.100 mm
Warning limits			-0.150 mm <O> 0.050 mm
Resolution length			0.001 mm
Name			D1
Display style			Digital
    			

Feature D1	Display	Setup 1	System 1
Display style			
Digital			
Dial and digital			
Bargraph and digital			
    			

Examples for display style 1 feature with tolerances, warning limits and max measuring function:

- "Digital" display style

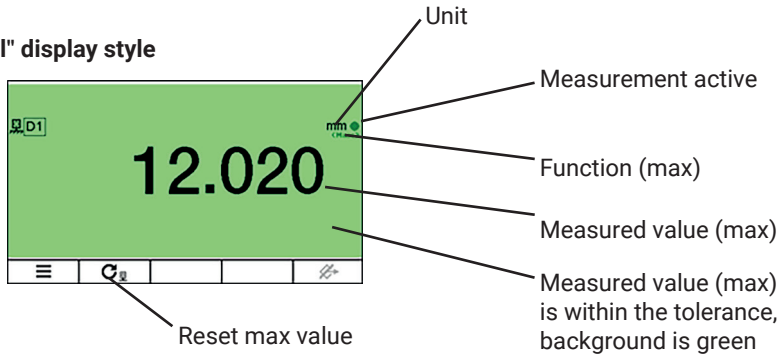

- "Dial and Digital" display style

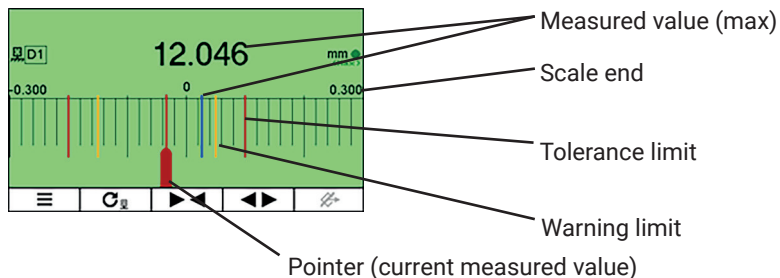



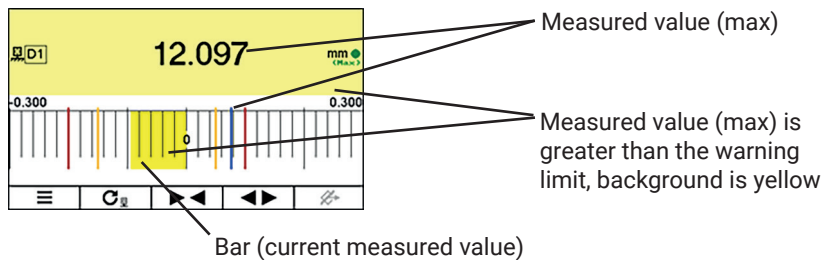



- "Bargraph and Digital" display style









3.2.9 Display center at

- Press the ON/OFF key
=> Menu appears.
- Use the ✕ key, ► or ◀ and  to select the **Feature (M1 / M2 / M3)** you wish to configure.
- Select the **Display center at** submenu using the ▼ or ▲ key.
- Select using ✓ key or exit submenu using the ✕ key.

Feature D1	Display	Setup 1	System 1		
Tolerance	-0.200 mm <O> 0.100 mm				
Warning limits	-0.150 mm <O> 0.050 mm				
Resolution length	0.001 mm				
Name	D1				
Display style	Dial and digital				
Display center at	Nominal value				
					

 **With asymmetric tolerances, the tolerance field might displayed outside the scaled analog display. In this case, it is advisable to center the display to the center of the tolerance rather than to the nominal size.**

- Use the ▲ or ▼ key to select the relevant centering.
- Use the ✓ key to confirm the selection or ✕ to exit the submenu.
- Use the  key to switch to measuring mode.

Feature D1	Display	Setup 1	System 1		
Display center at					
Nominal value					
Tolerance					
					

4 Display menu

4.1 Brightness

- Press the ON/OFF key
=> Menu appears.
- Press **✘**, **▶** or **◀** to select **Display** .
- Select the **Brightness** submenu using the **▼** or **▲** key.
- Select using **✓** key or exit submenu using the **✘** key.
- Use the **▲** or **▼** key to select the relevant **brightness**.
- Use the **✓** key to confirm the selection or **✘** to exit the submenu.

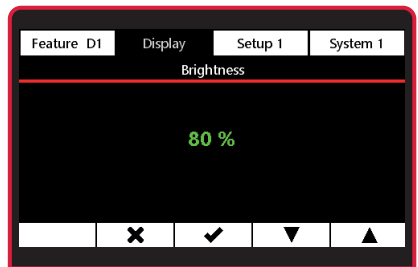
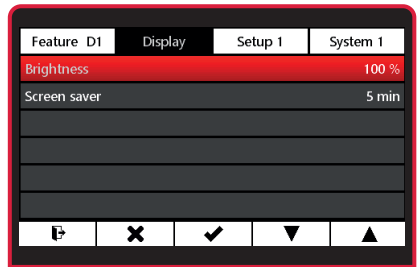

4.2 Screensaver

- Press the ON/OFF key
=> Menu appears.
- Press **✘**, **▶** or **◀** to select **Display** .
- Select the **Screensaver** submenu using the **▼** or **▲** key.
- Use the **✓** key to confirm the selection or the **✘** key to exit the submenu.
- Use the **▲** or **▼** key to select the relevant **time** before the screensaver activates.

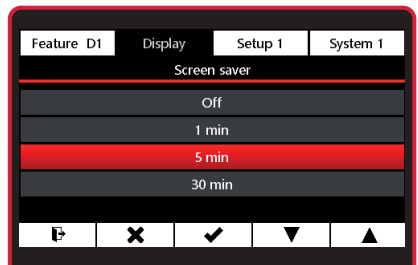
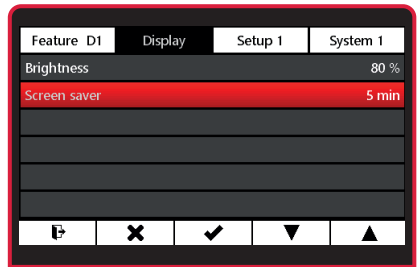

- Use the ✓ key to confirm the selection or ✕ to exit the submenu.
- Use the ↵ key to switch to measuring mode.



5 Setup

5.1 Setup 1

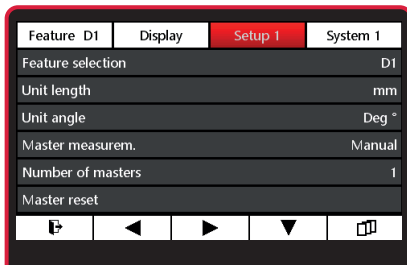
- Press the ON/OFF key => Menu appears.
- Press ✕, ▶ or ◀ and  to select Setup 1.



5.1.1 Feature selection

- Select the **Feature selection** submenu using the ▼ or ▲ key.
- Select using ✓ key or exit submenu using the ✕ key.
- **Make feature active:**
Use the ▲ or ▼ key to select the feature and activate with the  key.
- **Make feature passive:**
Use the ▲ or ▼ key to select the feature and deactivate with the  key.
- Use the ✓ key to confirm the selection or the ✕ key to exit the submenu.

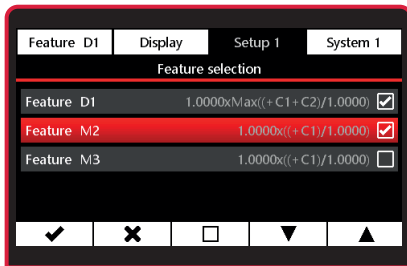
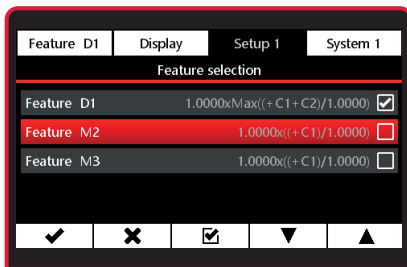
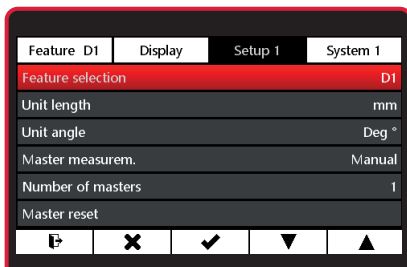

5.1.2 Unit length

- Select the **Unit length** submenu using the ▼ or ▲ key.
- Select using ✓ key or exit submenu using the ✕ key.
- Use the ▲ or ▼ key to select the relevant **unit**.
- Use the ✓ key to confirm the selection or ✕ to exit the submenu. Use the ↩ key to switch to measuring mode.

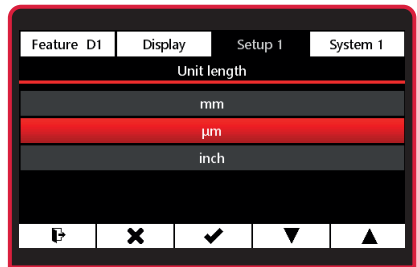
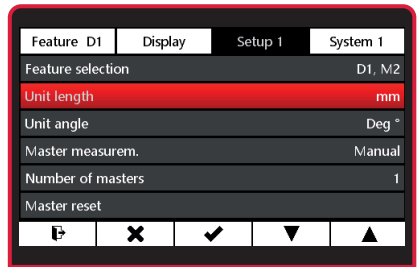

5.1.3 Unit angle

- Select the **Unit angle** submenu using the ▼ or ▲ key.
- Select using ✓ key or exit submenu using the ✕ key.
- Use the ▲ or ▼ key to select the relevant **unit**.
- Use the ✓ key to confirm the selection or ✕ to exit the submenu. Use the ↩ key to switch to measuring mode.

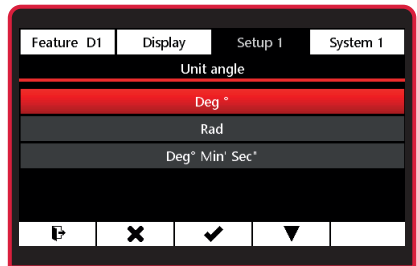
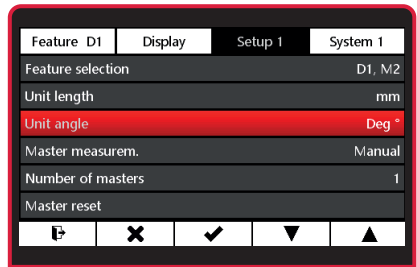

5.1.4 Master measurement mode

- Select the **Master measurement** submenu using the ▼ or ▲ key.
- Select using ✓ key or exit submenu using the ✕ key.
- Use the ▲ or ▼ key to select **Master measurement** mode.

Manual:

Master measurement is performed for the feature at which the hand is pointing.

Sequential:

Master measurement is performed for the feature at which the hand is pointing. Hand switches automatically to next feature.

Parallel:

Master measurement is performed for all active features at the same time.

- Select using ✓ key or exit submenu using the ✕ key.
Use the ↩ key to switch to measuring mode.

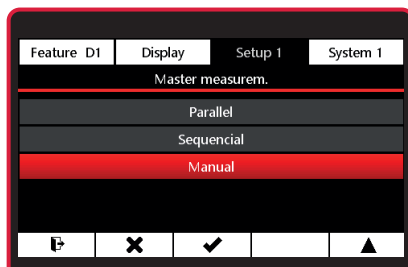
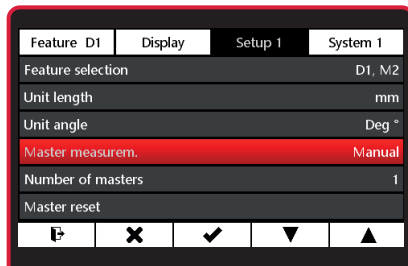

5.1.5 Number of masters

- Select the **Number of masters** submenu using the ▼ or ▲ key.
- Select using ✓ key or exit submenu using the ✕ key.
- Select the number of masters using the ▼ key.

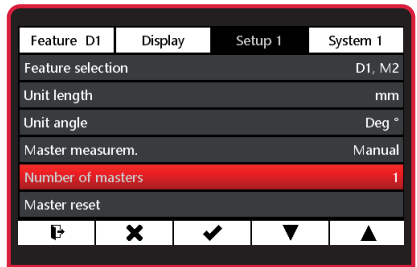

1 = one-point master measurement
2 = two-point master measurement
 see **Section 3.2.2. Master**

- Use the ✓ key to confirm the selection or ✕ to exit the submenu.
- Use the ◻ key to switch to measuring mode.

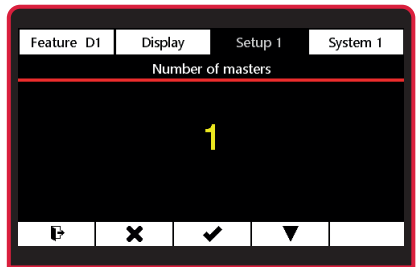

5.1.6 Master reset

- Select the **Master reset** submenu using the ▼ or ▲ key, or exit the submenu using the ✕ key or switch to measuring mode using the ◻ key.
- Use the ✓ key to delete the master values set in measuring mode. C 1202 switches to measuring mode. The values displayed now refer directly to the probe signal.

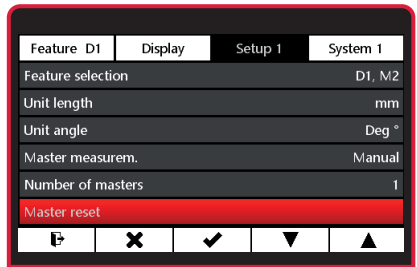

Master value is set

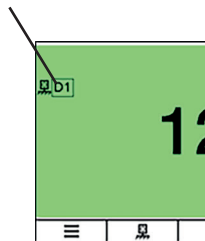

Master value is deleted

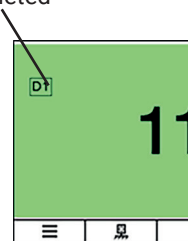

5.2 Setup 2

- Press the ON/OFF key
=> Menu appears.
- Press **✘**, **▶** or **◀** and  to select **Setup 2**.

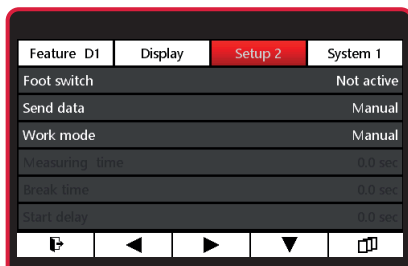



5.2.1 Foot switch (switching input)

- Select the **Foot switch** submenu using the **▼** or **▲** key.
- Select using **✓** key or exit submenu using the **✘** key.

Make the switching input function active:

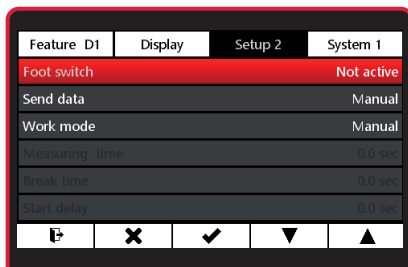
- Use the **▲** or **▼** key to select the function and activate with the  key.



-  You can only select functions that are available on the basis of the current settings. The other functions are grayed out.

Make switching input function passive:

- Use the **▲** or **▼** key to select the function and deactivate with the  key.

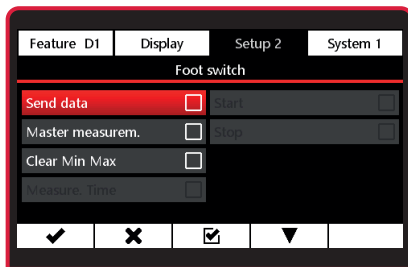



You can make several functions active. The functions will then be processed automatically in the logical order. In the example on the left, "Send data", "Start" and "Stop" are active functions of the foot switch. The first time you press the foot switch, the measurement will start. The second time you press the foot switch, the measurement will stop and the measured value will be sent via the interface.

- Use the ✓ key to confirm the selection or ✕ to exit the submenu.
- Use the ↵ key to switch to measuring mode.

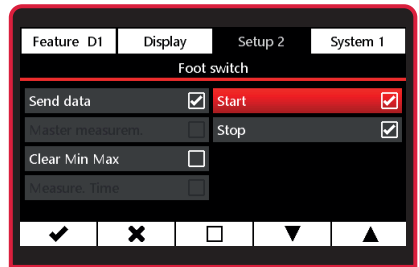

5.2.2 Sending data

- Select the **Send data** submenu using the ▼ or ▲ key.
- Select using ✓ key or exit submenu using the ✕ key.
- Use the ▲ or ▼ key to select the relevant **Send data** mode.

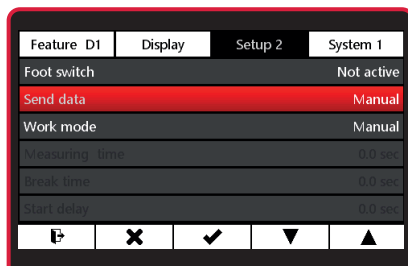

Manual:

Measured value for the feature at which the hand is pointing will be sent.

Sequential:

Measured value for the feature at which the hand is pointing will be sent. Hand switches automatically to next feature.

Parallel:

The measured values for all the active features will be sent one after the other.

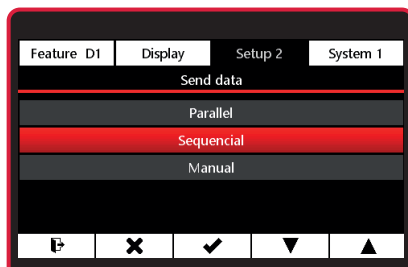

 If only one feature is active, only the measured value for the active feature will be sent, regardless of the selected mode.

- Use the ✓ key to confirm the selection or ✕ to exit the submenu.
- Use the ⏪ key to switch to measuring mode.

5.2.3 Work mode

- Select the **Work mode** submenu using the ▼ or ▲ key.
- Select using ✓ key or exit submenu using the ✕ key.
- Use the ▲ or ▼ key to select the relevant **Work mode**.

Manual:

The C 1202 continuously records measuring values. The active features are calculated on the basis of the **formula**, linking and function and the results are displayed. Use the \odot key to delete the max, min and average memory and start a new measurement.

If one of the settings (**Max+Min**)/2, **Max-Min** or **Average** was selected under **Formula**, the calculated total or difference or the average is continuously updated.

The \odot key resets the current value. A new measurement starts right away.

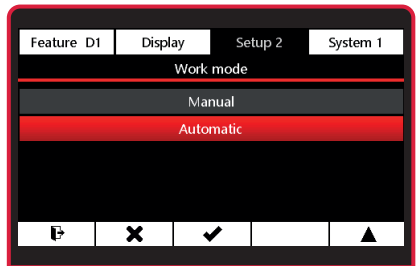
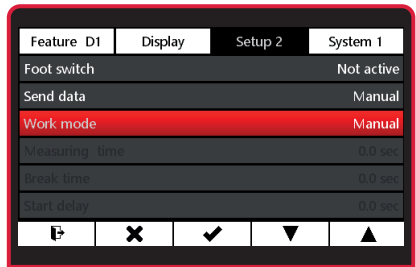

Automatic:

A measurement is started by pressing the ► key. The C 1202 then begins recording measuring values and calculates the formula for the active features based on the formula.

Pressing the ■ key ends the measurement and displays the results. The measurement recording then switches off. The recording of measurements can be paused with the || key (pause) and resumed with the ► key. This is helpful, e.g. for radial runout measurements with a discontinuous profile.



As long as a measuring routine is active, a green bar is displayed in the center box.

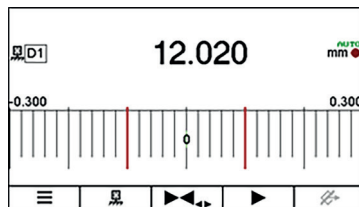

Ready to measure, measurement value display frozen

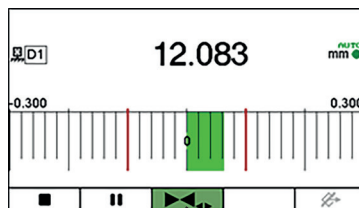

Measurement started

5.2.4 Measuring time

 The time specifications only apply in "Automatic" mode.

- Select the **Measuring time** submenu using the ▼ or ▲ key.
- Select using ✓ key or exit submenu using the ✕ key.
- Use the ► key to select the digit and the ▼ or ▲ key to enter the relevant value.
- Use the ✓ key to confirm the value or ✕ to exit the submenu.

 If a time other than "0" was set under "**Measuring time**", measurement stops automatically after this time. A green bar appears in the center box at the bottom for the duration of the set measuring time. The length of the bar indicates the lapsed time.

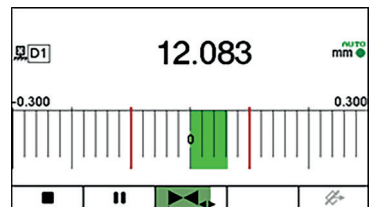
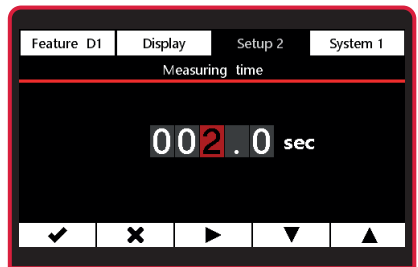
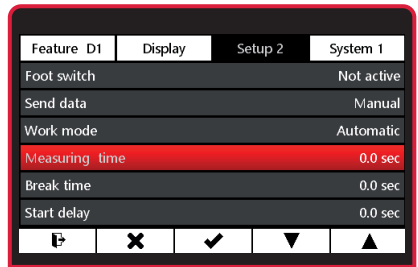

Measuring time active

5.2.5 Break time

- Select the **Break time** submenu using the ▼ or ▲ key.
- Select using ✓ key or exit submenu using the ✕ key.
- Use the ► key to select the digit and the ▼ or ▲ key to enter the relevant value.
- Use the ✓ key to confirm the value or ✕ to exit the submenu.



If a time other than "0" is entered under **Break time**, a new measurement will begin automatically once the **Break time** has elapsed.

A green bar appears in the fourth box at the bottom for the set break time. The length of the bar indicates the lapsed time.

The measurement and break sequence is paused by pressing the ■ key and resumed with the ► or ■ key.

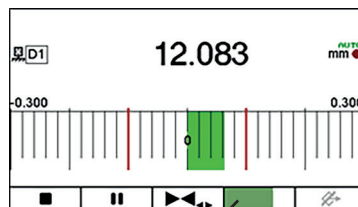

Break time active

5.2.6 Start delay

- Select the **Start delay** submenu using the ▼ or ▲ key.
- Select using ✓ key or exit submenu using the ✕ key.
- Use the ► key to select the digit and the ▼ or ▲ key to enter the relevant value.
- Use the ✓ key to confirm the value or ✕ to exit the submenu.

 If you want a certain amount of time to pass between the moment ► (Start) is pressed and the measurement starts, you can enter a time period by which the start of the measurement is delayed. A start delay is particularly useful when a dynamic measurement (e.g. on a shaft) is performed and it is supposed to start automatically via a switch contact on the measuring device. When the shaft is approached, vibrations occur in the measuring device that affect the measuring result. During the delay time, the vibrations subside and no longer affect the measuring result.

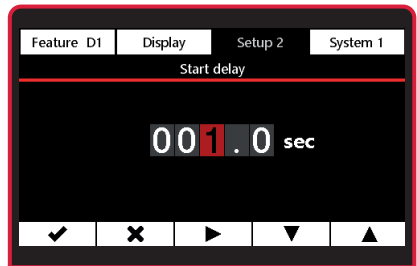
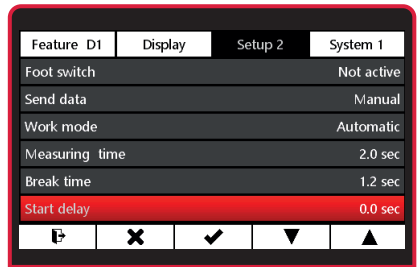

- Use **✕** to select the main menu. Use the **↔** key to switch to measuring mode.



A green bar appears in the second box at the bottom during the set start delay. The length of the bar indicates the lapsed time.

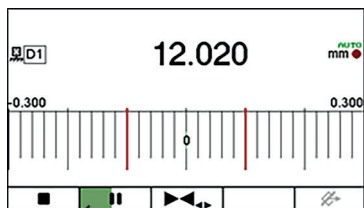

Start delay active

5.3 Setup 3

- Press the ON/OFF key
=> Menu appears.
- Press **✘**, **▶** or **◀** and  to select **Setup 3**.

Feature	D1	Display	Setup 3	System 1
Factor C1				1.0000
Factor C2				1.0000
Probe type C1				Mahr, Standard Range
Probe type C2				Mahr, Standard Range
Filter (Average of n-values)				1

5.3.1 Factor C1

Set the channel factor. Measured values from the sensor to channel 1 are multiplied by this factor.

- Select the **Factor C1** submenu using the **▼** or **▲** key.
- Select using **✓** key or exit submenu using the **✘** key.
- Use the **▶** key to select the digit and the **▼** or **▲** key to enter the relevant value.
- Use the **✓** key to confirm the value or **✘** to exit the submenu.

Feature	D1	Display	Setup 3	System 1
Factor C1				1.0000
Factor C2				1.0000
Probe type C1				Mahr, Standard Range
Probe type C2				Mahr, Standard Range
Filter (Average of n-values)				1

Feature	D1	Display	Setup 3	System 1
Factor C1				
+001.0000				

5.3.2 Factor C2

Set the channel factor. Measured values from the sensor to channel 2 are multiplied by this factor.

-  Implement the settings as described under 5.3.1 Factor C1.

Feature	D1	Display	Setup 3	System 1
Factor C1				1.0000
Factor C2				1.0000
Probe type C1				Mahr, Standard Range
Probe type C2				Mahr, Standard Range
Filter (Average of n-values)				1

5.3.3 Probe type C1

- Select the **Probe type C1** submenu using the ▼ or ▲ key.
- Select using ✓ key or exit submenu using the ✖ key.
- Select the relevant probe type using ▼ or ▲.



If the N 1702 M module is being used, the measuring signal from the sensor is multiplied by the following factor

Standard Range: x 1

Long Range: x10



For compatible probes, see Section 8.2.

- Select using ✓ key or cancel using ✖ key.
- Exit submenu with ✖ or exit the settings menu by pressing the ↩ key.

5.3.4 Probe type C2

Select probe type for channel C2



Implement the settings as described under 5.3.3 Probe type C1.

Feature D1	Display	Setup 3	System 1
Factor C1			1.0000
Factor C2			1.0000
Probe type C1		Mahr, Standard Range	
Probe type C2		Mahr, Standard Range	
Filter (Average of n-values)			1

Feature D1	Display	Setup 3	System 1
Probe type C1, Mahr			
Standard Range			
Long Range			

Feature D1	Display	Setup 3	System 1
Factor C1			1.0000
Factor C2			1.0000
Probe type C1		Mahr, Standard Range	
Probe type C2		Mahr, Standard Range	
Filter (Average of n-values)			1

5.3.5 Filters (Average of n-values)

- Select the **Filter** submenu using the ▼ or ▲ key.
- Select using ✓ key or exit submenu using the ✕ key.
- Use the ▼ or ▲ key to select the number of values for filtering.

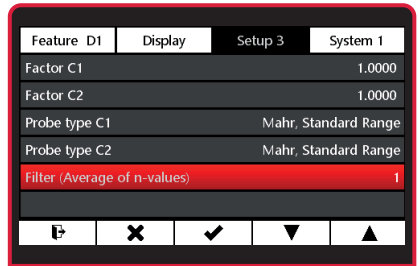

 The sliding average is formed from the selected number of values and displayed as a measured value. Then the oldest value is deleted and a new value is added to calculate the new average and display it as a measured value.

- Use the ✓ key to confirm the selection or the ✕ key to exit the submenu.
- Use the  key to switch to measuring mode.

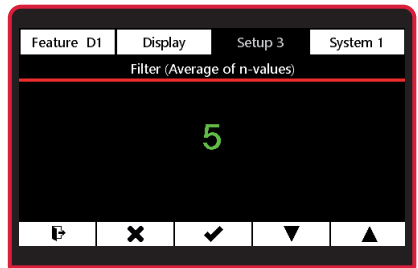

 The signals of the probes can be filtered in order to avoid disturbances caused by grooves or dirt on the workpiece. The number of values for filtering can be set between 1 and 16. As a rule: the higher the set value, the greater the filter effect.

6 System

6.1 System 1

- Press the ON/OFF key
=> Menu appears.
- Press **✖**, **▶** or **◀** and  to select **System 1**.

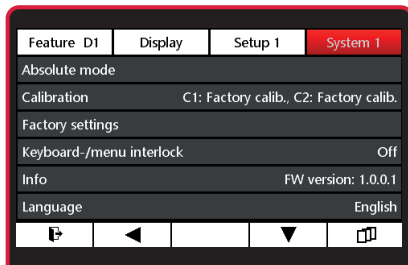

6.1.1 Setting up the transducer

- Select the **Absolute mode** using the **▼** or **▲** key.
- Select using **✓** key or exit submenu using the **✖** key.

 One or two measuring channels will appear, depending on the N 1700 module used. The value displayed is the direct value from the measuring sensor.

- Adjust measuring probe mechanically close to "0".
- The scaling can be adjusted with the **▶◀** or **◀▶** key.
- Press the  key to leave the settings menu.

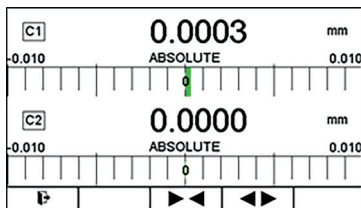
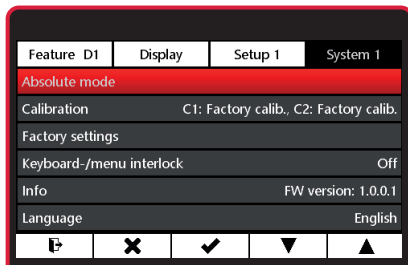

6.1.2 Calibration

- Select the **Calibration** submenu using the ▼ or ▲ key.
- Select using ✓ key or exit submenu using the ✕ key.

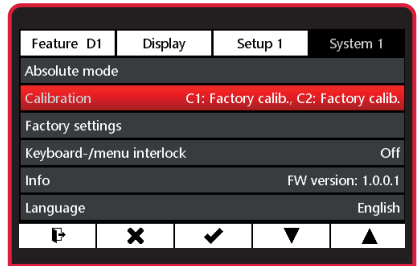

6.1.2.1 Calibration C1

- Select the **Calibration C1** submenu using the ▼ or ▲ key.
- Select using ✓ key or exit submenu using the ✕ key.

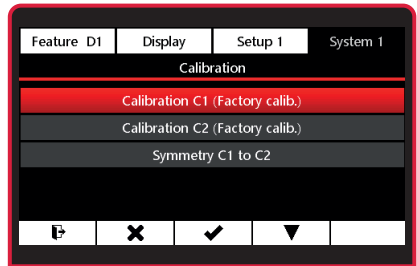

6.1.2.1.1 Customer calibration activation

If a customer calibration is already available, it can be activated by selecting this menu item.

- **Select Customer calibration activation** using the ▼ or ▲ key.
- Select using ✓ key or exit submenu using the ✕ key.

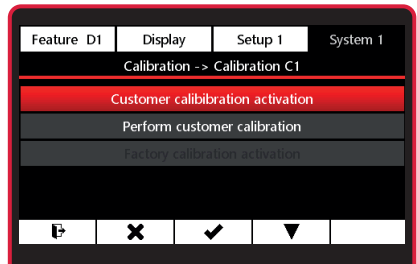

 The active correction for the measuring channel is displayed under **Calibration** in the menu.

C1: Customer calibration
C2: Factory calibration

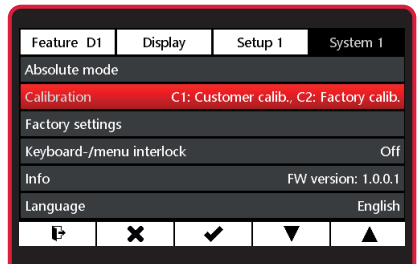

 The instrument is most accurate after approx. 30 minutes of operation. To perform a reliable customer calibration using a probe, the probe's electrical zero point should be positioned at the calibration zero point using the probe's raw value display. (see point 6.1.1.).

This is because the inductive probe measures most accurately at the electrical zero point. The probe's electrical zero point should be set on a 1.000 mm gage block for a customer calibration, like the one in this example, where a 2.000 mm gage block is used for the MAX value and the measuring plate represents the MIN value.

6.1.2.1.2 Performing customer calibration

- Select the **Calibration** submenu using the ▼ or ▲ key.
- Select using ✓
- Select the **Calibration C1** submenu using the ▼ or ▲ key.
- Select using ✓
- **Select Perform customer calibration** using the ▼ or ▲ key.
- Select using ✓ key or exit submenu using the ✕ key.
- Use ► to select the value for **Calibration min**.
- Use the ✓ key to select the **Calibration min** submenu.

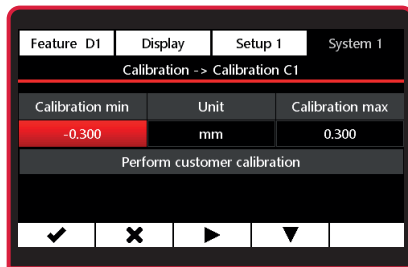
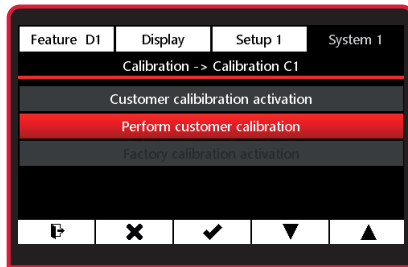

- Use the ► key to select the digit and the ▼ or ▲ key to enter the relevant value.
- Use the ✓ key to confirm the value or ✕ to exit the submenu.
- Use ► to select the value for **Calibration max** and enter the relevant value as explained above.
- To execute the customer calibration, use the ▼ key to select **Perform customer calibration**.

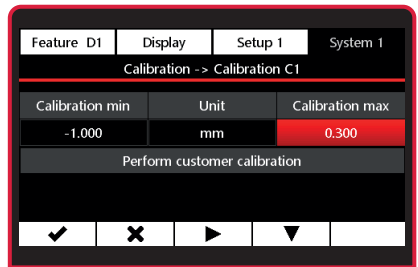
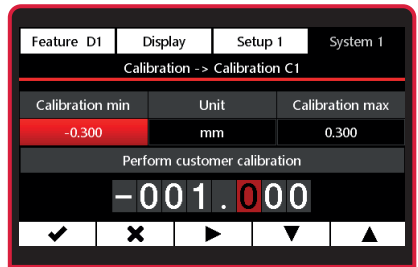

- Use the ✓ key to confirm the value or ✕ to exit the submenu.

 The display shows information on how to position the probe.

- Use the ✓ key to confirm the value or ✕ to cancel the process.

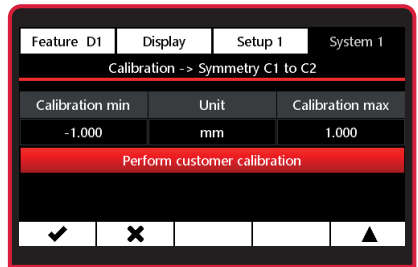

Progress of the measurement is indicated by a green progress bar.

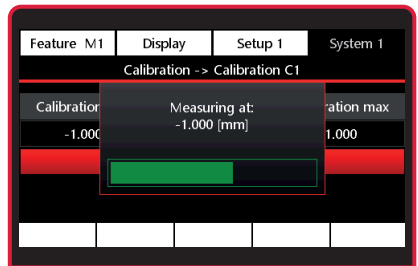

The display shows information on how to position the probe for the second measuring point.

- Use the **✓** key to confirm the value or **✗** to cancel the process.
- Following successful measurement, press **✓** to activate the customer calibration or **✗** to cancel the process.

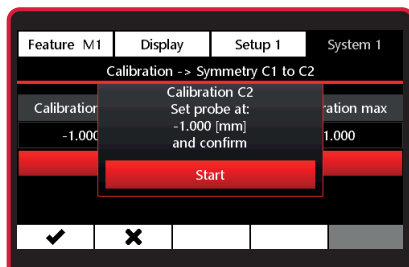

An error message appears if the measured values of the customer calibration are not plausible.

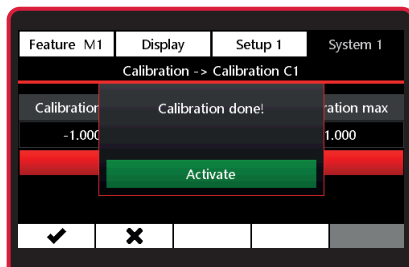

- Use **✓** to repeat the customer calibration or **✗** to cancel the process.

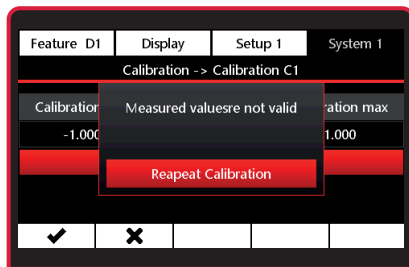

To avoid any measurement errors that may be caused by a previously created customer calibration, it is advisable to activate the factory standard calibration again. This is always stored in the measuring instrument and is not changed by the customer calibrations.

6.1.2.1.3 Activating a factory calibration

- Select the **Calibration** submenu using the ▼ or ▲ key.
- Select using ✓
- Select the **Calibration C1** submenu using the ▼ or ▲ key.
- Select using ✓
- Select **Factory calibration activation** using the ▼ or ▲ key.



The active correction for the measuring channel is displayed under **Calibration** in the menu.

C1: Customer calibration

C2: Factory calibration

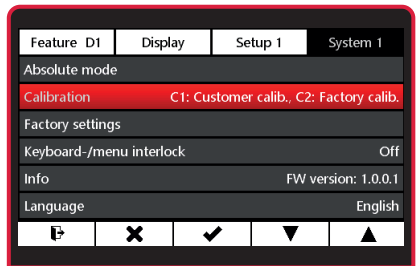
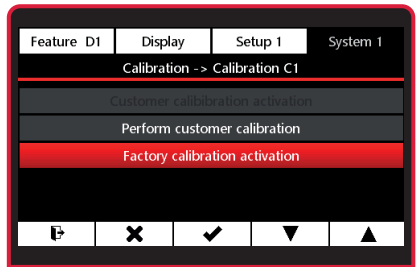

6.1.2.2 Calibration C2

- Select the **Calibration** submenu using the ▼ or ▲ key.
- Select using ✓ key or exit submenu using the ✕ key.
- Select the **Calibration C2** submenu using the ▼ or ▲ key.

Settings and corrections can now be performed for channel C2 as described under 6.1.2.1 **Calibration C1**.

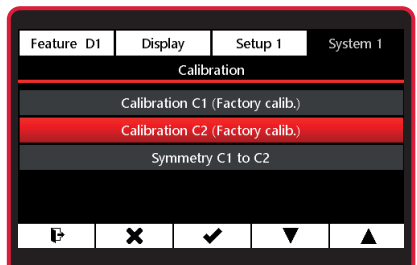



The instrument is most accurate after approx. 30 minutes of operation. To reliably balance two probes, the probes' electrical zero points should be positioned at the calibration zero points using the probe raw value display. (see point 6.1.1.). This is because the inductive probe measures most accurately at the electrical zero point. A 1.000 mm gage block would be the perfect electrical zero point in our example, where a 2.000 mm gage block is used for the MAX value and the measuring plate represents the MIN value.

6.1.2.3 Symmetry C1 to C2

When balancing two probes, a customer calibration is performed on the two probes at both measuring channels in succession.

- Select the **Calibration** submenu using the ▼ or ▲ key.
- Select using ✓.
- Select the **Symmetry C1 to C2** submenu using the ▼ or ▲ key.
- Select using ✓ key or exit submenu using the ✕ key.
- Use ► to select the value for **Calibration min**.
- Use the ✓ key to select the **Calibration min** submenu.
- Use the ► key to select the digit and

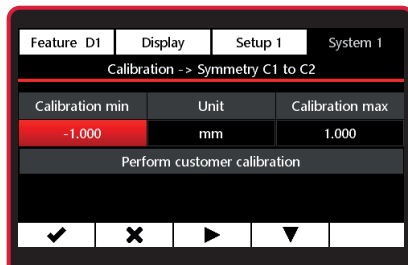
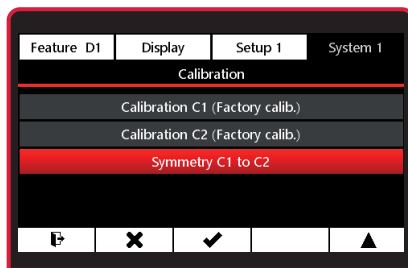

the ▼ or ▲ key to enter the relevant value.

- Use the ✓ key to confirm the value or ✘ to exit the submenu.

- Use ► to select the value for **Calibration max** and enter the relevant value as explained above.

- To balance, use the ▼ key to select **Perform customer calibration**.

- Use the ✓ key to confirm the value or ✘ to exit the submenu.

The display shows information on how to position the probe at C1.

- Use the ✓ key to confirm or ✘ to cancel the process.

Progress of the measurement is indicated by a green progress bar.

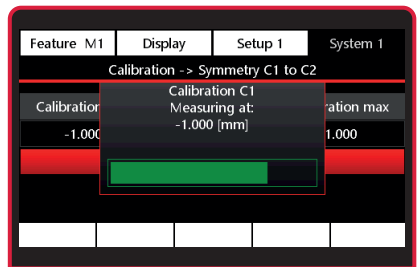
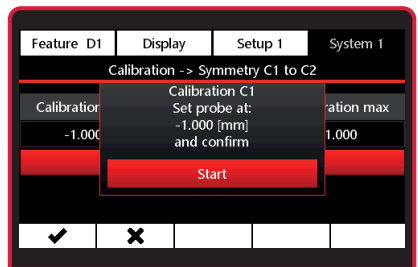
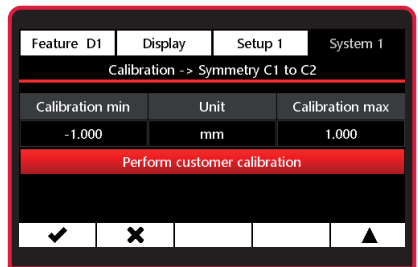
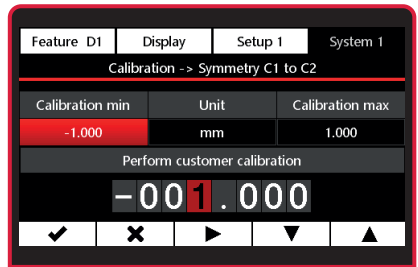

The display shows information on how to position the probe at C1 for the second measuring point.

- Use the ✓ key to confirm or ✗ to cancel the process.

Then go through the same process for the probe at C2.

- Use the ✓ key to confirm or ✗ to cancel the process.

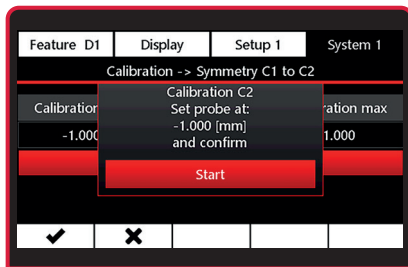
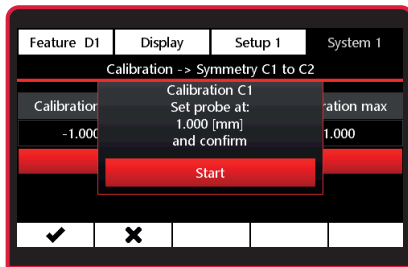

- Following successful measurement, press ✓ to activate the customer calibration or ✗ to cancel the process.



An error message appears if the measured values of the customer calibration are not plausible.

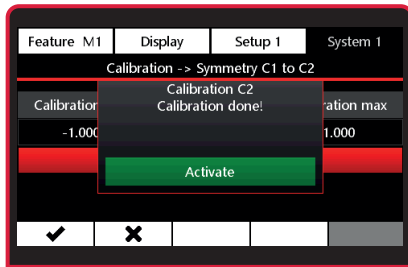

- Use ✓ to repeat the customer calibration or ✗ to cancel the process.

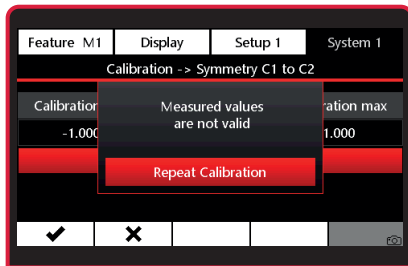

6.1.3 Factory settings

- Select the **Factory settings** submenu using the ▼ or ▲ key.
- Select using ✓ key or exit submenu using the ✕ key.
- **Select action** with ▼ or ▲ key.

No = cancel



Yes = instrument is reset to factory settings.

- Select using ✓ key or exit submenu using the ✕ key.

Progress is indicated by a green progress bar.

At the end of the process, the C1202 restarts. The start screen appears briefly. The language and unit of measurement need to be selected. See also initial commissioning, Section 2.

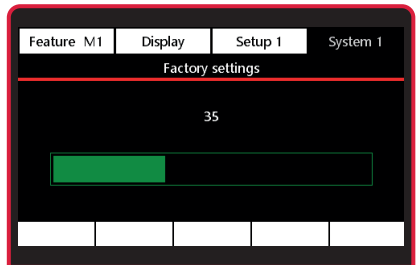
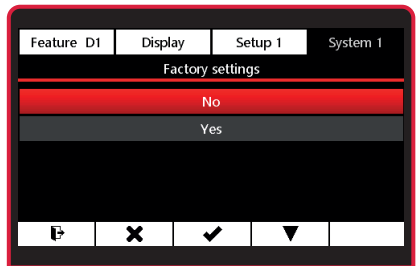
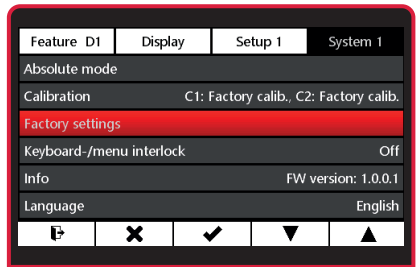

6.1.4 Menu interlock

- Select the **Menu interlock** submenu using the ▼ or ▲ key.
- Select using ✓ key or exit submenu using the ✕ key.
- **Select action** with ▼ or ▲ key.

Off = switch off lock

On = switch on lock with PIN already entered.

! To activate the lock, the PIN must not be 0000.

- Select using ✓ key or exit submenu using the ✕ key.
- Press the ▼ key to edit the PIN.
- Use the ► key to select the position and the ▼ or ▲ keys to enter the relevant value.
- Use the ✓ key to confirm the value and activate the lock or ✕ to exit the submenu.

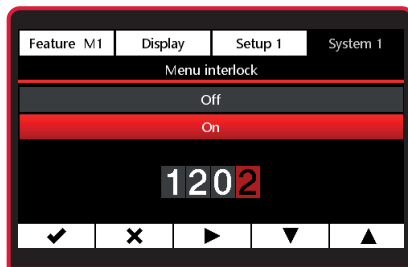
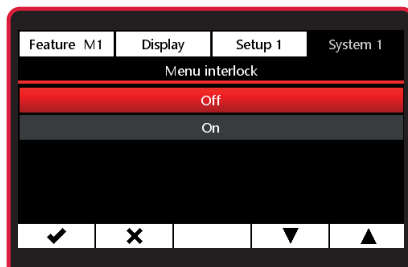
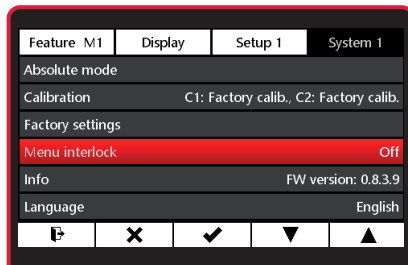

If the menu lock is switched on, the user will be prompted to enter the PIN when opening the menu. The menu will open once the PIN has been entered correctly.

 The menu lock remains deactivated for another minute after exiting the menu. This means that the PIN does not have to be re-entered every time you exit the menu for adjustments.

 If you have forgotten the PIN, you can request the master PIN from Mahr GmbH.

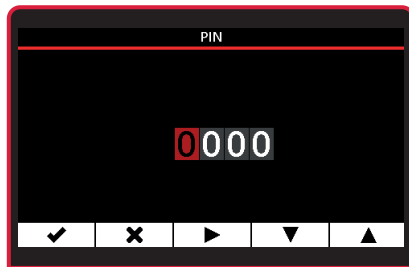

6.1.5 Info

- Select the **Info** submenu using the ▼ or ▲ key.
- Select using ✓ key or exit submenu using the ✕ key.

The following information appears about the C 1202 and the N 1700 module currently in use.

Name, article number, serial number and firmware version.

- Press ✕ to exit the info display.
- Use the ↵ key to switch to measuring mode.

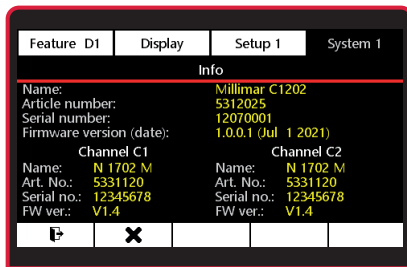
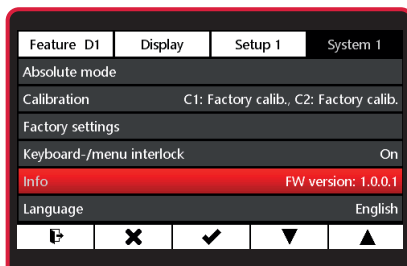

6.1.6 Selecting the language

- Select the **Language** submenu using the ▼ or ▲ key.
- Select using ✓ key or exit submenu using the ✕ key.
- Select the relevant language with the ▼ or ▲ keys.
- Use the ✓ key to confirm the selection or ✕ to exit the submenu.
- Use the ↵ key to switch to measuring mode.

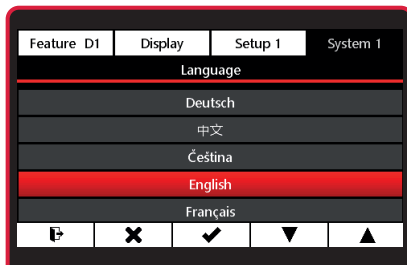
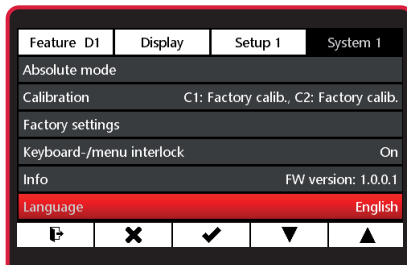

6.2 System 2

- Press the ON/OFF key
=> Menu appears.
- Press **✖**, **▶** or **◀** and  to select **System 2**.

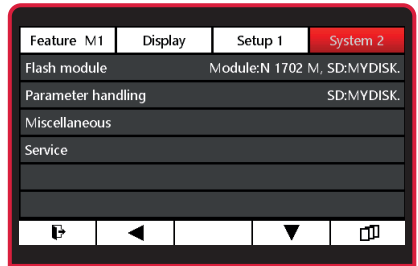

6.2.1 Updating module N 1700

- ! The firmware file for the N 1700 module must first be copied to a Micro SD card using a PC. The card is then inserted into the C 1202.
- Select the **Flash module** submenu using the **▼** or **▲** key.
- Select using **✓** key or exit submenu using the **✖** key.
- Use **▼** or **▲** to select the firmware file for the N 1700 module in use, or exit the submenu using the **✖** key.

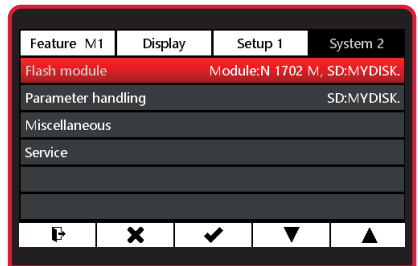

- ! Please check that the right firmware file is saved on the Micro SD card. If the wrong firmware is sent to the N 1700 module, it will stop working and will have to be sent to Mahr Service.

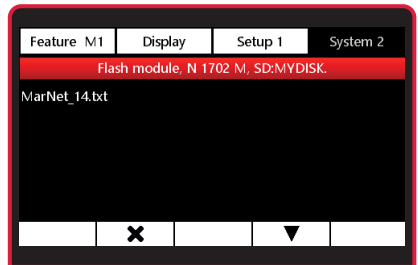

- Confirm selection by pressing key **✓**

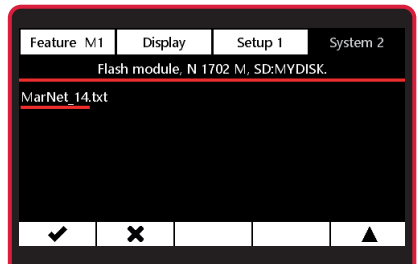

The display shows which module is in use.

- Use the ✓ key to start the update or ✗ to cancel the process.

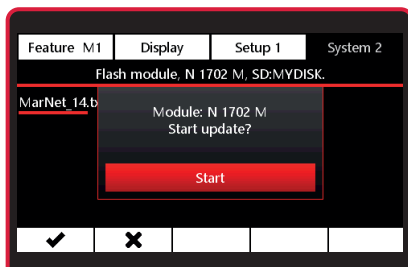

Progress is indicated by a green progress bar.

- Following successful update of the N 1700 module, open the menu with the ✓ key.

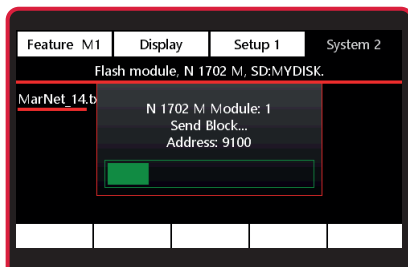

- If the update was not successful, an error message appears.

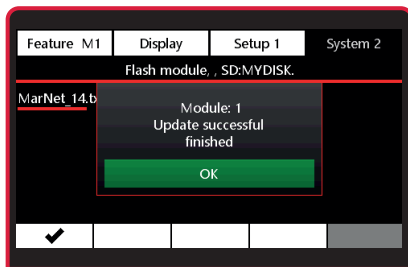





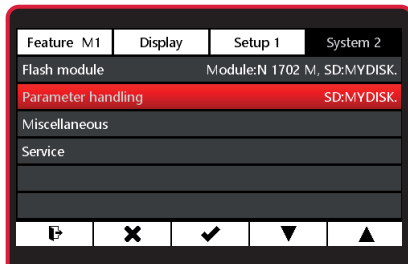

6.2.2 Managing parameters

! A Micro SD card must be inserted in the C 1202 to save or load setting parameters.

- Select the **Parameter handling** submenu using the ▼ or ▲ key.
- Select using ✓ key or exit submenu using the ✗ key.







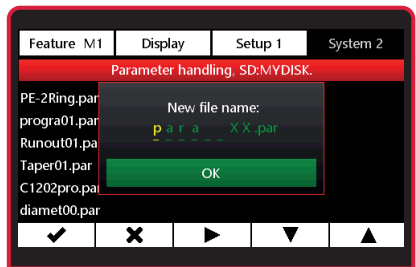

Saving parameters

- Press the  key. The most up-to-date parameters are saved to the Micro SD card as a new file.
- Enter the name for the parameter file. Use the  key to select the digit and the  or  key to enter the relevant characters. Any six characters can be assigned as the name. A consecutive 2-digit number is added automatically. Possible characters (a...z, 0...9, -, _) Press  to save parameters, or  to cancel the entries.



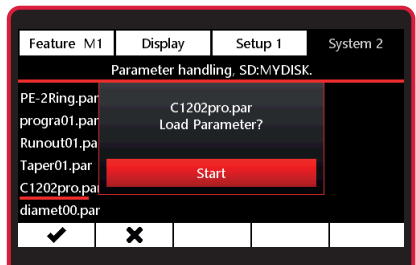

Loading parameters

- Press  or  to select the parameter file, or  to exit the submenu.
- Confirm selection by pressing key  ✓
- Press  to load the parameter file or  to cancel the process.



Deleting the parameter file

- Press ▼ or ▲ to select the parameter file to be deleted, or ✕ to exit the submenu.
- Confirm selection by pressing 
- Press  to delete the parameter file or ✕ to cancel the process.

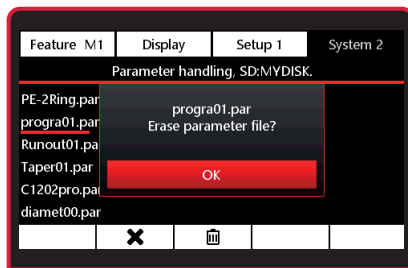

6.2.3 Miscellaneous

- Select the **Miscellaneous** submenu using the ▼ or ▲ key.
- Select using ✓ key or exit submenu using the ✕ key.
- **Make function active:**
Use the ▼ or ▲ key to select the function and activate with the .

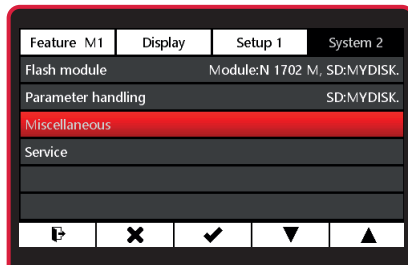

- **Make function passive:**
Use the ▼ or ▲ key to select the function and deactivate with the key.
- Use the ✓ key to confirm the selection or the ✕ key to cancel the process.

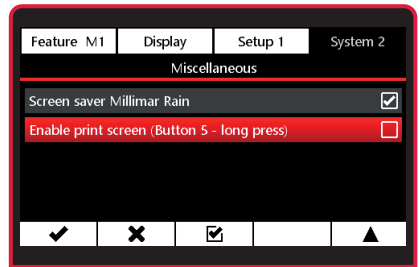

Screen saver "Millimar Rain"
After the time set in the Display/Screensaver menu (Section 4.2) has elapsed, the "Millimar Rain" screensaver will activate, otherwise the screen's backlight will darken.

Enable print screen (Button 5 - long press)
If this function is activated, you can save a copy of the current screen to the Micro SD card by holding down key 5.

! A Micro SD card must be inserted in the C 1202 for this.

6.2.4 Service

! This is a menu item for Mahr Service. The submenu can only be opened with the Service password.

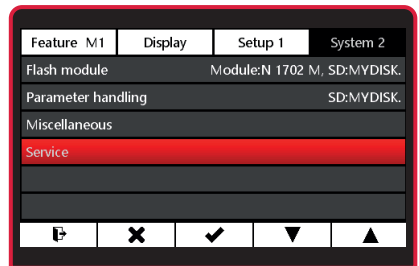

7 Description of the interfaces

7.1 Compatible data cables

- **USB data cable DK-U1 Order no. 4102603**

Transmission parameters:

Transmission speed: 9600 baud, 1 start bit, 7 ASCII bits, even parity, 2 stop bits

Further information can be found in the data cable operating instructions.

Set nominal size	MPNOML2, cmax(f0),_unit MPNOML2, cmin(f0),_unit MPNOML2, cmax(f1),_unit MPNOML2, cmin(f1),_unit unit = mm/deg./inch	nominal value for max(f0),_unit nominal value for min(f0),_unit nominal value for max(f1),_unit nominal value for min(f1),_unit if the value of pitch are recorded, the response will be ERK2.	1_ - 30.0000_m 1_ - 5_ 0.0000_deg 1_ - 13.2456_inch 2_ - 2000.0000_m 2_ - 2000.0000_deg 2_ - 2000.0000_inch 3_ - 300.0000_m 3_ - 300.0000_deg 3_ - 300.0000_inch unit = mm/deg./inch	min(f0) value for unit "mm": 1.000 0000 min(f0) value for unit "deg": 1.000 0000 min(f1) value for unit "mm": 1.000 0000 min(f1) value for unit "deg": 1.000 0000 min(f1) value for unit "inch": 1.000 0000 if the value of pitch are recorded, the response will be ERK2.
Retrieve all the available nominal sizes	MPNOML2	returns all the available nominal sizes separated by ";" according to the response selected in "Setup (feature selection)".	-	min(f0) value "mm": 1.000 0000 min(f0) value for unit "deg": 1.000 0000 min(f1) value for unit "mm": 1.000 0000 min(f1) value for unit "deg": 1.000 0000 min(f1) value for unit "inch": 1.000 0000 if the value of pitch are recorded, the response will be ERK2. Upper limit > lower limit if upper limit > lower limit, the warning limit will be corrected automatically. if upper limit < upper warn. limit, then upper warn. limit > upper limit if lower limit < lower warn. limit, then lower warn. limit < lower limit
Set tolerance limits	TM1L_1, cmax(f0),_unit TM1L_1, cmin(f0),_unit TM1L_1, cmax(f1),_unit TM1L_1, cmin(f1),_unit unit = mm/deg./inch	tolerance limits maximum number of places depends on active unit from 000.0000; inch 3X 000.0000; deg 3X 000.0000 Every decimal number must contain 3 "0".	TM1L_1, 300.0_ 0.0000_m TM1L_1, 300.0_ 0.0000_deg TM1L_1, 300.0_ 0.0000_inch unit = mm/deg./inch	min(f0) value for unit "mm": 1.000 0000 min(f0) value for unit "deg": 1.000 0000 min(f1) value for unit "mm": 1.000 0000 min(f1) value for unit "deg": 1.000 0000 min(f1) value for unit "inch": 1.000 0000 if the value of pitch are recorded, the response will be ERK2. Upper limit > lower limit if upper limit > lower limit, the warning limit will be corrected automatically. if upper limit < upper warn. limit, then upper warn. limit > upper limit if lower limit < lower warn. limit, then lower warn. limit < lower limit
Retrieve all the available tolerance limits	TM12	returns all the available tolerance limits separated by ";" according to the response selected in "Setup (feature selection)".	-	min(f0) value for unit "mm": 1.000 0000 min(f0) value for unit "deg": 1.000 0000 min(f1) value for unit "mm": 1.000 0000 min(f1) value for unit "deg": 1.000 0000 min(f1) value for unit "inch": 1.000 0000 if the value of pitch are recorded, the response will be ERK2.
Set warning limits	TM14L_1, cmax(f0),_unit TM14L_1, cmin(f0),_unit TM14L_1, cmax(f1),_unit TM14L_1, cmin(f1),_unit unit = mm/deg./inch	warning limits maximum number of places depends on active unit from 000.0000; inch 3X 000.0000; deg 3X 000.0000 Every decimal number must contain 3 "0".	TM14L_1, 100.0_ 0.0000_m TM14L_1, 100.0_ 0.0000_deg TM14L_1, 100.0_ 0.0000_inch unit = mm/deg./inch	min(f0) value for unit "mm": 1.000 0000 min(f0) value for unit "deg": 1.000 0000 min(f1) value for unit "mm": 1.000 0000 min(f1) value for unit "deg": 1.000 0000 min(f1) value for unit "inch": 1.000 0000 if the value of pitch are recorded, the response will be ERK2. Upper warn. limit > lower warn. limit if upper warn. limit > lower warn. limit, the warning limit will be corrected automatically. if upper warn. limit < upper warn. limit + upper warn. limit + upper warn. limit
Retrieve all the available warning limits	TM14P	returns all the available warning limits separated by ";" according to the response selected in "Setup (feature selection)".	-	min(f0) value for unit "mm": 1.000 0000 min(f0) value for unit "deg": 1.000 0000 min(f1) value for unit "mm": 1.000 0000 min(f1) value for unit "deg": 1.000 0000 min(f1) value for unit "inch": 1.000 0000 if the value of pitch are recorded, the response will be ERK2. Upper warn. limit > lower warn. limit if upper warn. limit > lower warn. limit, the warning limit will be corrected automatically. if upper warn. limit < upper warn. limit + upper warn. limit + upper warn. limit
Set new password	UC_ cnew(PN),_cUP(PN)	new password	UC -	returns all the available tolerance limits separated by ";" according to the response selected in "Setup (feature selection)".
Lock menu	UC1	lock menu	LOCK1	
Unlock menu	UC0	unlock menu	LOCK0	
Error messages:				
Measured value outside of permitted range	ERR0			
Invalid command or syntax error	ERR2			
Order cannot be executed	ERR3			
This function is not possible in the current functions loaded	ERR4			
Data is incomplete	ERR5			
No data	ERR6			
Menu active	ERR7			

8 Technical data

8.1 Compact length measuring instrument Millimar C 1202

Product type C 1202
 Order no. 5312025
 Compatibility: Depends on N 1700 module being used
 Display: TFT color display, 4.3 inch, 480 (W) x 272(H) pixels
 Keypad: Membrane keypad, 1 million actuations
 Units: μm , mm, inch, degrees°, Rad, degrees° Min´ Sec´´

Range of digital display: ± 999.99999 mm; ± 999999.99 μm ;
 ± 39.3700000 inch
 $\pm 999.99999^\circ$; ± 6.9800000 rad; $\pm 399^\circ 59' 59''$

Range of analog display:

Measuring range / μm	± 5000	± 2000	± 1000	± 300	± 100	± 30	± 10	± 3
Measuring range / mm	± 5	± 2	± 1	± 0.3	± 0.1	± 0.03	± 0.01	± 0.003
Measuring range / inch	± 0.19	± 0.07	± 0.03	± 0.01	± 0.003	± 0.001	± 0.0004	± 0.0001
Dial graduation / μm	500	200	100	20	10	2	1	0.2
Measuring range / degrees	$\pm 100^\circ$	$\pm 30^\circ$	$\pm 10^\circ$	$\pm 3^\circ$	$\pm 1^\circ$	$\pm 0.3^\circ$	$\pm 0.1^\circ$	$\pm 0.03^\circ$
Measuring range / Rad	± 1.5	± 0.5	± 0.1	± 0.05	± 0.01	± 0.005	± 0.001	± 0.0003
Measuring range /								
Degrees Min Sec	$\pm 100^\circ$	$\pm 30^\circ$	$\pm 10^\circ$	$\pm 3^\circ$	$\pm 60'$	$\pm 18'$	$\pm 6'$	$\pm 1'$
Scale division / degrees	10°	2°	1°	0.2°	0.1°	0.02°	0.01°	0.002°

Resolution:

μm : 10; 1; 0.1; 0.01* (*only with N 1702 M-HR)
 mm: 0.01; 0.001; 0.0001; 0.00001*
 inch: 0.0001; 0.00001; 0.000005; 0.0000005*
 Degrees°: 0.001°; 0.0001°; 0.000005°
 Rad: 0.00001; 0.000001; 0.0000005
 Degrees° Min´ Sec´´ 1´´

Tolerance display:	Background color green / yellow / red
Measuring ranges, inductive probe:	Depends on N 1700 module being used
Sensor inputs:	via N 1700 module, maximum 2
Data transfer rate USB:	1 feature active: 28 values per second
Measuring combinations:	+A / -A / +B / -B / +A+B / +A-B / -A+B / -A-B
Measuring functions:	None, Max, Min, Max-Min, (Max+Min)/2, Average, atan
Features:	3
Refresh rate:	20 to 40 fps (frames per second) depending on measuring task
Error limit, digital display	
with measuring module N 1702 M:	0.2 μm / 0.3% of displayed probe value**
with measuring module N 1702 M-HR:	0.04 μm / 0.3% of displayed probe value**
	** The larger value applies
Error limit, scale display:	0.25 % of scale end value / 0.3% of displayed value ***
	*** The larger value applies
Data interface:	USB,
hardware interface:	USB, control input, RS485, Micro SD slot
Power supply:	Mains powered 100 -240 Volt / 12V, 1.5 A
IP protection class:	42
Weight excluding module:	778 G
Operating temperature range:	0°C – 40°C ****
Storage temperature range:	-10°C – 50°C
Dimensions W/H/D:	Angle of the display 25 degrees: 130/115/140 mm Angle of the display - 90 degrees: 130/175/140 mm
Distance between mounting holes:	62 mm

**** **To achieve maximum accuracy, the instrument must be at operating temperature. Operating temperature is reached after approx. 30 mins. of being switch on. The information on accuracy is based on a room temperature of 20°C in accordance with ISO 1.**

8.2 Compatible probes for the Millimar C 1202

depends on the N 1700 measuring module used

C1202 + N 1702 M	
5312025 + 5331120	
Mahr compatibility	
Standard range	
Carrier frequency	19.4 kHz
Sensitivity	192 mV/V/mm
Amplitude	5 Veff
Type	Order no.
1301	5313010
1303	5313030
1304K	5313049
1318	5313180
P1300MA	4400180
P1300MB	4400181
P2001M	5323040
P2004M	5323010
P2004MA	5323020
P2004MB	5323030
P2104MA	5324070
P2104MB	5324080
Long range	
Carrier frequency	19.4 kHz
Sensitivity	19.2 mV/V/mm
Amplitude	5 Veff
Type	Order no.
P2010M	5324010
P2010MA	5324020
P2010MB	5324030

C1202 + N 1702 T	
5312025 + 5331121	
TESA compatibility	
Standard range	
Carrier frequency	13 kHz
Sensitivity	73.75 mV/V/mm
Amplitude	3 Veff
Type	Order no.
P1300TA	4400190
P1300TB	4400191
P2004T	5323011
P2004TA	5323021
P2004TB	5323031
P2104TA	5324071
P2104TB	5324081
Long range	
Carrier frequency	13 kHz
Sensitivity	29.5 mV/V/mm
Amplitude	3 Veff
Type	Order no.
P2010TA	5324021
P2010TB	5324031

C1202 + N 1702 U	
5312025 + 5331122	
Marposs compatibility	
Standard range	
Carrier frequency	7.5 kHz
Sensitivity	115 mV/V/mm
Amplitude	3.5 Veff
Type	Order no.
P2004U	5323013
P2004UA	5323023
P2004UB	5323033
P2104UA	5324073
P2104UB	5324083
Long range	
Carrier frequency	7.5 kHz
Sensitivity	11.5 mV/V/mm
Amplitude	3.5 Veff
Type	Order no.
P2010UA	5324023
P2010UB	5324033

9 Accessories

9.1 Compatible N 1700 measuring modules

5331120	Millimar N 1702 M	Module for 2 inductive probes
5331121	Millimar N 1702 T	Module for 2 inductive probes
5331122	Millimar N 1702 U	Module for 2 inductive probes
5331161	Millimar N 1702 Vss *	Module for 2 incremental probes
5331150	Millimar N 1701 PM-2500	Module for 1 pneum. measuring instrument
5331151	Millimar N 1701 PM-5000	Module for 1 pneum. measuring instrument
5331152	Millimar N 1701 PM-10000	Module for 1 pneum. measuring instrument
5331155	Millimar N 1701 PF-2500/5000	Module for 1 pneum. measuring instrument
5331156	Millimar N 1702 PF-2500/5000 4J	Module for 1 pneum. measuring instrument
5331157	Millimar N 1701 PF-10000	Module for 1 pneum. measuring instrument

* from firmware C 1202 version 1.1.0.0

9.2 Other accessories

4102603	DK-U1, USB data cable
4102058	Foot switch 16 ESf
2258471	PF air filter with fine pressure regulator 2.1 bar
2258476	PM air filter with fine pressure regulator 2.0 bar
5312950	Extension rail for fitting two N 1701 PF/PM modules