



Compact length measuring instrument



Millimar C 1202

Quick guide

Valid from firmware version 1.0.0.0

3722972

Mahr GmbH

Carl-Mahr-Straße 1

37073 Göttingen

Tel. +49 551 7073 0

info@mahr.com, www.mahr.com

0123



Dear customer,

Thank you for choosing a product by Mahr GmbH. We kindly request that you follow the instructions below to ensure the long-term precision of your instrument.

We operate a policy of continuous improvement and are constantly developing our products. Therefore, it is possible that there may be slight differences between the text and illustrations in this document and the instrument in your possession, especially with regard to type designations. We reserve the right to make changes to the design and scope of supply, the right to undertake further technical developments, and all rights relating to translation of this documentation.

© by Mahr GmbH

The following symbols are used in these operating instructions:



General information



Caution



Caution, hazard

Failure to follow instructions marked with this symbol can cause inaccurate results and lead to equipment damage.

Introduction

Permitted uses

The Millimar C 1202 is an electronic length measuring and evaluation instrument for use in production. Depending on the N 1700 module used, e.g. two inductive or incremental measuring probes, one or two pneumatic measuring instruments can be connected.

The operating, maintenance and repair information detailed in this quick guide and these operating instructions must be followed.

To gain maximum benefit from this measuring instrument, you must read the instructions before placing it into operation.

The measuring instrument is most accurate after a warm-up period of at least 30 minutes.

The Millimar C 1202 must only be used with the supplied AC adapter.

The detailed operating instructions can be downloaded at www.mahr.com/products on the product page.

The scope of delivery of the length measuring instrument includes:

- Millimar C 1202 measuring instrument
- AC adapter with interchangeable adapter
- Bus termination module
- Micro SD memory card
- Quick guide

! Forfeiture of warranty

Service work caused by viruses that were introduced via a network connection or other data carrier, are generally excluded from warranty services.

Storage temperatures below -10°C or above $+50^{\circ}\text{C}$ and relative humidity levels above 85% will invalidate the warranty for the instrument.

Safety information

This instrument complies with the relevant safety regulations. It was dispatched from our production facility in a good condition and perfect working order. However, failure to follow the instructions given below can cause personal injury or death.

1. Before you connect up and use the measuring instrument for the first time, please read the accompanying documentation.
Follow the safety precautions detailed in the quick guide and operating instructions.
2. Keep the documentation close to the measuring instrument ready for quick reference.
3. Follow all safety precautions, accident prevention regulations and internal company rules and guidelines. If necessary you should request further information from your company safety officer.
4. Before connecting up this measuring instrument, please check the local mains supply voltage to ensure that it is within the working range of the AC adaptor (100 V - 240 V, 50 Hz - 60 Hz).
If they do not match, this measuring instrument must not be connected under any circumstances!
5. The instrument may only be connected to a grounded power socket which complies with the regulations of the local power supply company.
This also applies to any extension cables that are used.
6. Only use original and intact AC adapters.
7. When connecting inductive probes, ensure that the plugs are firmly screwed onto the connection sockets.
8. Do not drop the instrument and make sure it is positioned securely.
9. Do not operate the instrument in areas where there is a risk of explosion and do not expose it to direct sunlight!
10. Do not clean the membrane keypad with solvent-based cleaning agents.
11. The instrument must not be opened.
12. The test and measuring equipment, for which the Millimar is used, are subject to inspection equipment monitoring.
For this reason, regular inspection equipment monitoring performed by either the user or Mahr Service must ensure compliance with the specified error limits for the test and measuring equipment.

Important notes prior to using the length measuring instrument

- The measuring instrument may only be used for its intended purpose. No liability will be accepted for damages caused by other usage or as a result of the incorrect application of this measuring instrument.
- Should your measuring task not be solved with this measuring instrument, we can offer you another solution from our product range. Please provide us with details of your measuring task.

! Do not use an electric marking tool.

Disposal information

Electronic equipment which was purchased from Mahr after March 23, 2006 can be returned to us. We will dispose of this equipment in an environmentally-friendly way.

The valid EU directives (WEEE, ElektroG) apply.

Confirmation of traceability

We declare, with sole responsibility, that this product conforms with standards and technical data as specified in our sales documents (operating instructions, leaflet, catalog). We certify that the testing equipment used to check this product, and guaranteed by our Quality Assurance, is traceable to national standards.

Thank you for placing your trust in us by purchasing this product.

EU/UK Declaration of Conformity

This measuring instrument complies with the applicable EU/UK directives.



A copy of the current Declaration of Conformity is available to download at www.mahr.com/products on the page for the relevant product and can be requested from the following address: Mahr GmbH, Carl-Mahr-Straße 1, D-37073 Göttingen

Order no.	Last modification	Version
3722972	17.05.2021	Valid from firmware version 1.0.0.0

Table of contents

1. Delivery and connection

- 1.1 Unpacking 6
- 1.2 Scope of delivery 7
- 1.3 Inserting the measuring module 8
- 1.4 Symbols 10
- 1.5 Operating elements and interfaces 12
 - 1.5.1 Display and operating keys 12
 - 1.5.2 Keys with dual function 13
 - 1.5.3 Mode display for master measurement 14
 - 1.5.4 Ports 14

2. Initial commissioning (applying basic settings)

- 2.1 Switching on 15
- 2.2 Selecting the display language 15
- 2.3 Setting the measurement unit 15
- 2.4 Connecting the measuring probe 16
- 2.5 Selecting the probe type 16
- 2.6 Setting up the probe 18
- 2.7 Measuring screen 19
- 2.8 Switching OFF 19

1. Delivery and connections

1.1 Unpacking

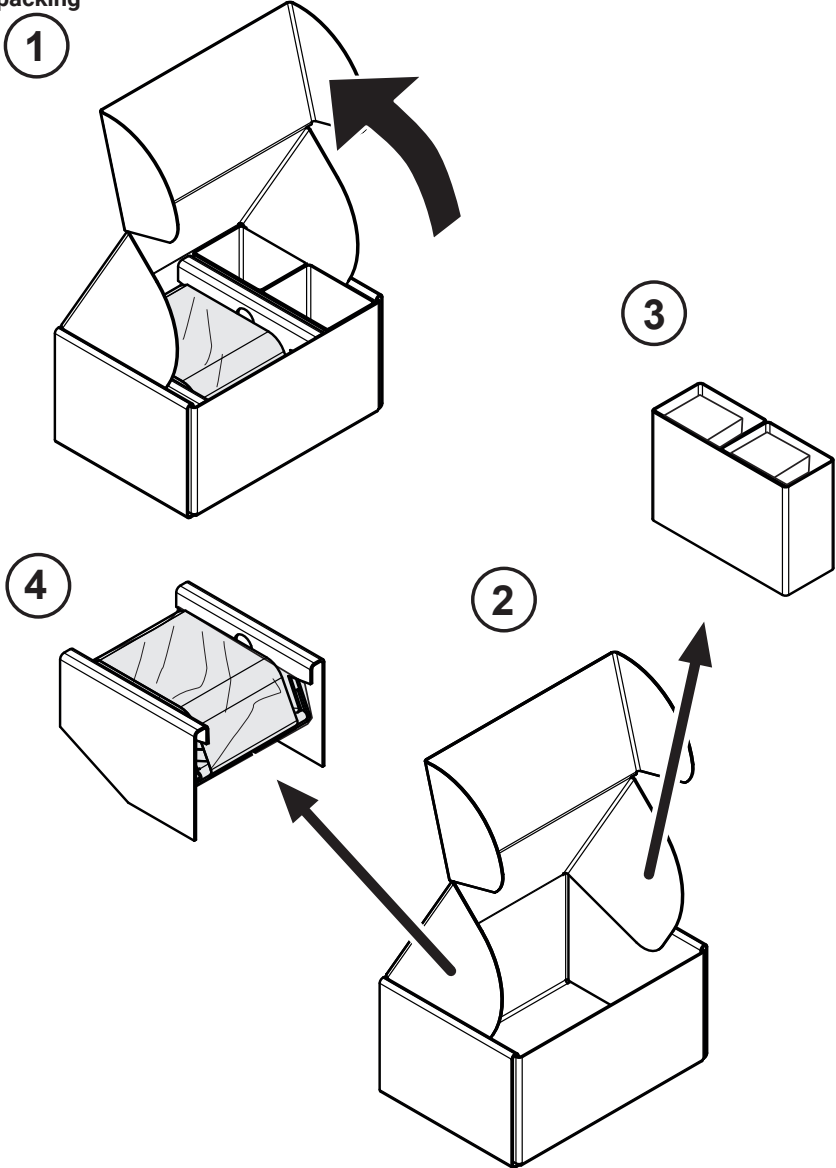

5

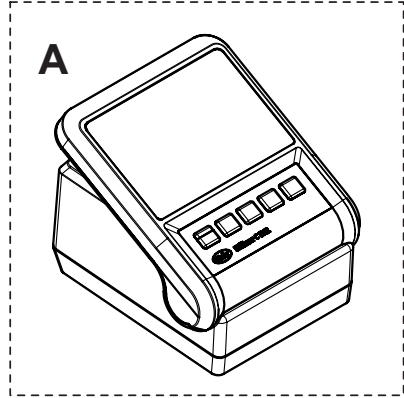
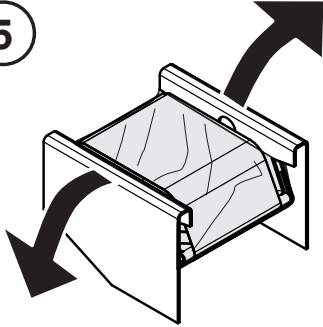

6

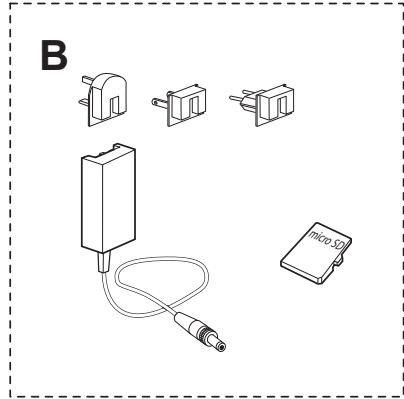
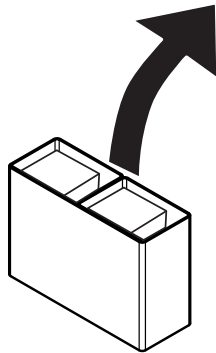

1.2 Scope of delivery

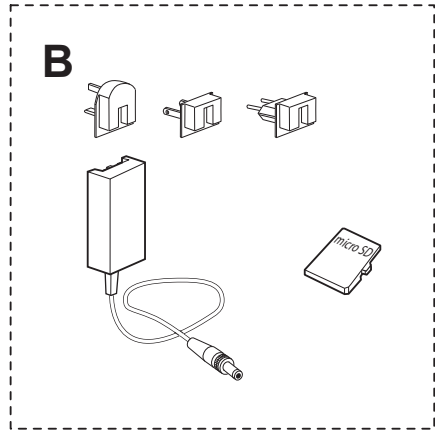
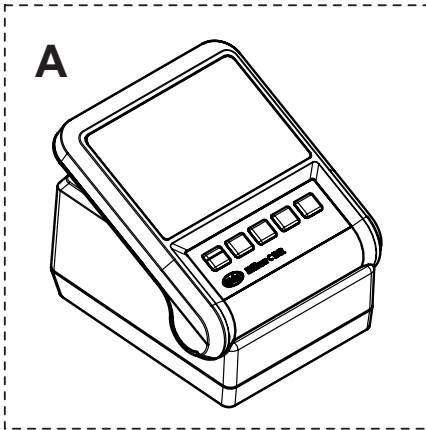

Scope of delivery

- Millimar C 1202
- Power supply unit with interchangeable adapter
- Bus termination module
- Micro SD memory card
- Quick guide

Bus termination module fitted in C 1202

Slot for Micro SD memory card

1.3 Using the measuring module



**Measuring module N 1700 is not included with delivery of the C 1202.
A measuring module is required to operate the C 1202.**

- Slide measuring module N 1700 with bus termination module onto the rail as far as the stop.
- Push the two red slide catches down so that the measuring module and the bus termination module cannot come out accidentally.



Measuring module N 1700 is removed in the reverse order.

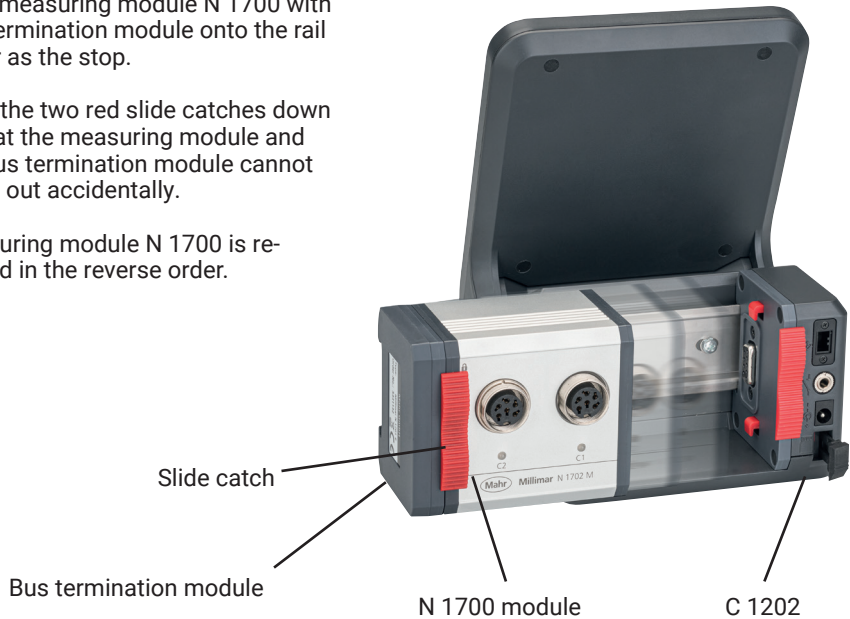



























Compatible N 1700 measuring modules:





















5331120	Millimar N 1702 M	Module for 2 inductive probes
5331121	Millimar N 1702 T	Module for 2 inductive probes
5331122	Millimar N 1702 U	Module for 2 inductive probes
5331125	Millimar N 1702 M-HR	Module for 2 inductive probes
5331161	Millimar N 1702 Vss	Module for 2 incremental probes
5331150	Millimar N 1701 PM-2500	Module for 1 pneumatic measuring instrument
5331151	Millimar N 1701 PM-5000	Module for 1 pneumatic measuring instrument
5331152	Millimar N 1701 PM-10000	Module for 1 pneumatic measuring instrument
5331155	Millimar N 1701 PF-2500/5000	Module for 1 pneumatic measuring instrument
5331156	Millimar N 1701 PF-PF25./50. 4-J	Module for 1 pneumatic measuring instrument
5331157	Millimar N 1701 PF-10000	Module for 1 pneumatic measuring instrument



Up to two N 1701 PM and N 1701 PF measuring modules can be used at the same time.

1.4 Symbols

Start screen			
	Select menu		
	Set zero point		
	Set zero point manual		
	Set zero point sequential		
	Set zero point parallel		
	Set zero point. Hold down Toggle function		Reset max, min memory. Hold down Toggle function
	Set zero point manual Hold down Toggle function		Reset max, min memory manual Hold down Toggle function
	Set zero point sequential Hold down Toggle function		Reset max, min memory sequential Hold down Toggle function
	Set zero point parallel Hold down Toggle function		Reset max, min memory parallel Hold down Toggle function
	Data transfer disabled, no connection		Data transfer
	Data transfer Manual, disabled		Data transfer manual
	Data transfer Sequential, disabled		Data transfer sequential
	Data transfer Parallel, disabled		Data transfer parallel
	Reduce the resolution		Increase the resolution
	Reduce the resolution Hold down Toggle function		Increase the resolution Hold down Toggle function
	Selecting a feature		

Settings menu			
	Select menu		Exit menu
	Scroll to the left		Scroll to the right
	Scroll down		Scroll up
	Select submenu		
	Confirm selection/entry		Cancel submenu/entry
	Select item		Deselect item
	Save settings to memory card		Delete file from memory card
"Time controlled" measuring mode			
	Start measurement		
	Pause measurement		Stop measurement
	Reset max, min memory.		
	Select feature Hold down Toggle function		Select feature disabled Hold down Toggle function
	Start measurement Hold down Toggle function		

1.5 Operating elements and interfaces

1.5.1 Display and operating keys

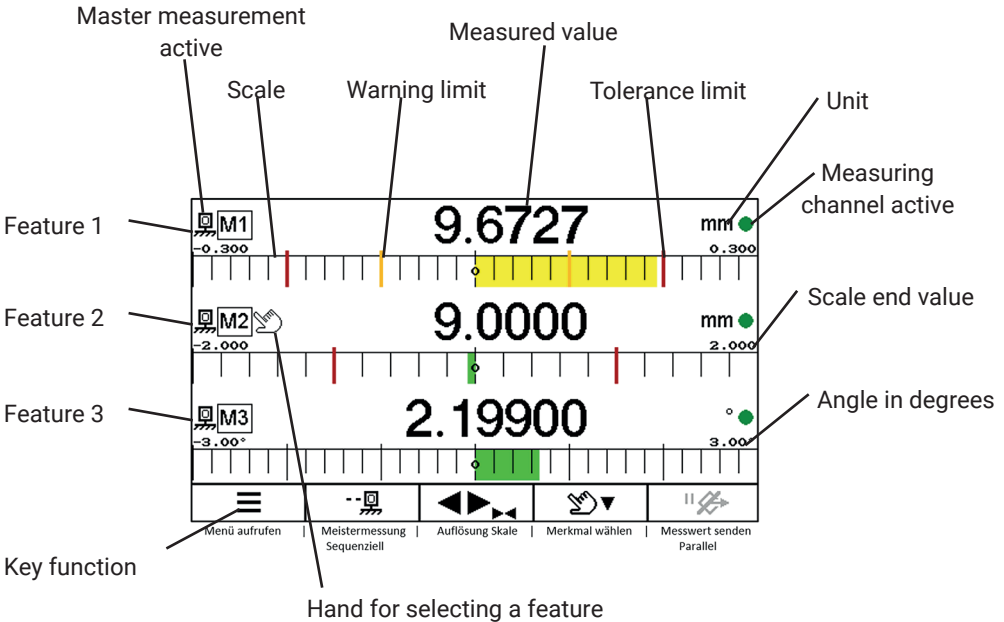
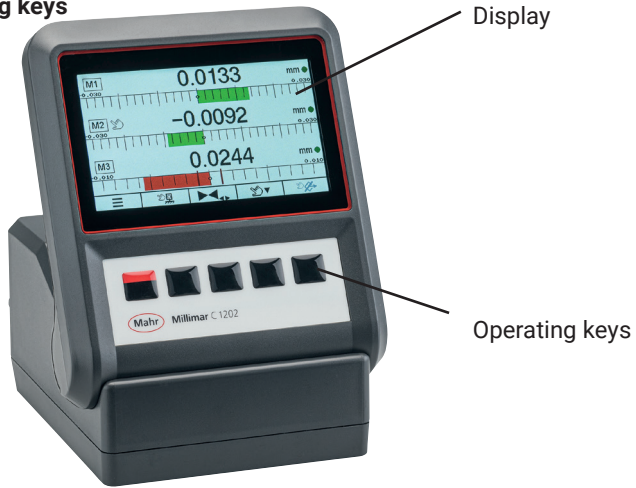

1.5.2 Keys with dual function

 Some keys have two functions.
Pressing the key for longer than two seconds toggles the function.

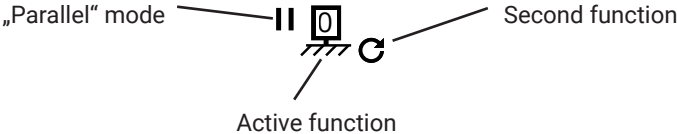

Increase scale resolution



Reduce scale resolution



Hand, select feature



Start measurement
in **time controlled** mode



Master measurement



Reset extreme value memory

1.5.3 Mode display for master measurement

Manual mode

=> Master measurement is performed for the feature at which the hand is pointing



Sequential mode

=> Master measurement is performed for the feature at which the hand is pointing. Hand switches automatically to next feature. The master measurement can now be performed for this feature.



Parallel mode

=> Master measurement is performed for all active features at the same time.



1.5.4 Ports

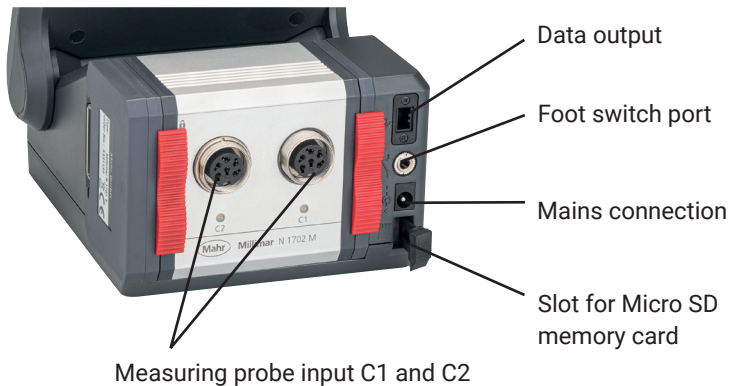

2. Initial operation

2.1 Switching ON

- Connect the mains adapter to the measuring instrument and mains socket
 - Press the ON / OFF key
- => The following appears on the display:

Start screen

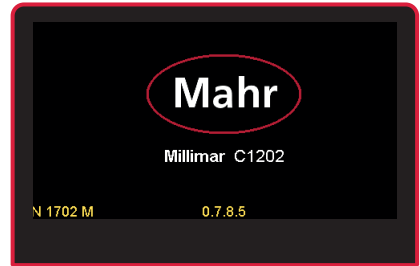

2.2 Selecting the display language

- Select the relevant language with ▼ or ▲
- Confirm entry by pressing ✓ key

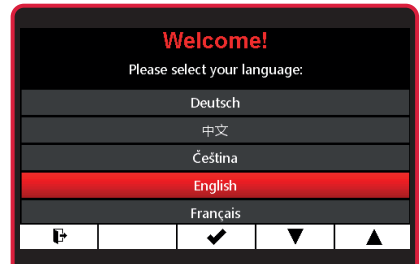

2.3 Setting the measurement unit

- Select the relevant measuring unit with ▼ or ▲
- Confirm entry by pressing ✓ key

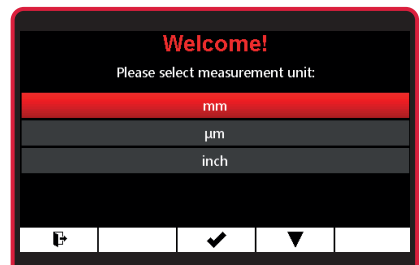

2.4 Connecting the measuring probe

- Connect the measuring probe to probe input C1



Probe input C1 and C2

2.5 Selecting the probe type

Press the ON/OFF key

=> Menu appears



- Select **Setup 3** with ► or ◀ and 

Feature	M1	Display	Setup 3	System 1
Factor C1				1.0000
Factor C2				1.0000
Probe type C1				Mahr, Standard
Probe type C2				Mahr, Standard
Filter (Average of n-values)				1
				

- Select submenu **Probe type C1** with ▼ or ▲

- Select using ✓ key or exit submenu using ✕ key

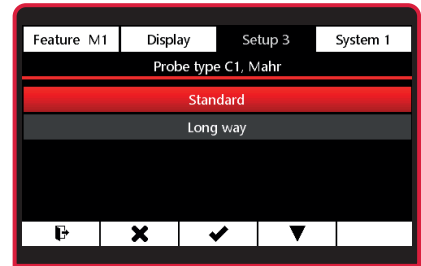

Feature	M1	Display	Setup 3	System 1
Factor C1				1.0000
Factor C2				1.0000
Probe type C1				Mahr, Standard
Probe type C2				Mahr, Standard
Filter (Average of n-values)				1
				

- Select the relevant measuring probe type using ▼ or ▲
- => See Technical Data in the operating instructions for compatible measuring probes.
- Confirm entry by pressing ✓ key or cancel with ✕ key
- Exit submenu with ✕ or exit the settings menu by pressing the ↩ key.



- ! *The instrument is most accurate after approx. 30 minutes of operation. Inductive measuring probes should be mechanically set to the electrical zero point before the first measurement. To do this, use the setup mode that indicates the raw value or absolute value of the probe.*

2.6 Setting up the probe

- Press the ON/OFF key
- => Menu appears
- Select **System 1** with ► or ◀ and 
- Select **Absolute mode** submenu with ▼
- Confirm entry with ✓ key or exit submenu with ✕ key
-  One or two measuring channels will appear. Depends on N 1700 module used. The value displayed is the direct value from the measuring sensor.
- Adjust measuring probe mechanically close to "0"
- The scaling can be adjusted with the ◀◀ or ▶▶ key
- Exit the settings menu by pressing the  key.

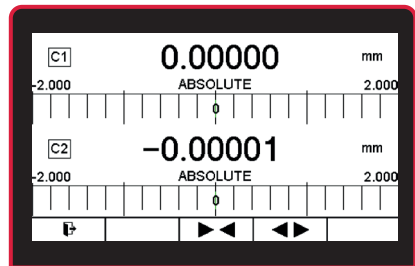
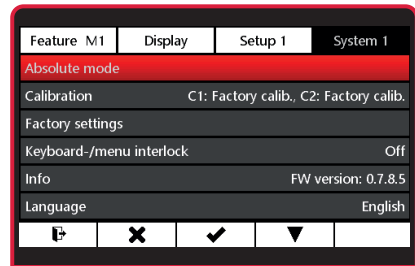
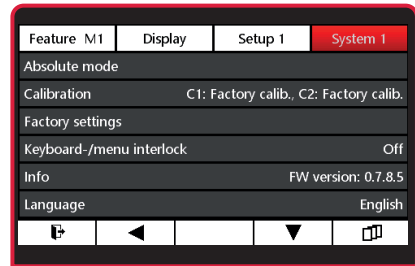

2.7 Measuring screen

- Press the ON/OFF key
- => Measuring screen appears
- Display value can be set to master value with  key
- => Master value = 0

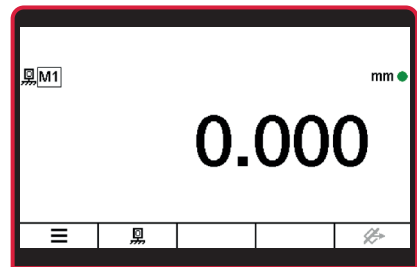

2.8 Switching OFF

- ! The measuring screen must be active to switch off the C1202 using the ON/OFF key.
- Press ON/OFF key for at least 2 seconds. The instrument switches off.

 The detailed operating instructions can be downloaded at www.mahr.com/products on the product page.



